



 **COREX**

Collegamenti flessibili in treccia  
*Braided flexible connections*

Trecce di massa  
*Earthing braids*

Barre flessibili  
*Flexible bars*

Giunti lamellari  
*Laminated shunts*

# INDICE | CONTENTS

	Caratteristiche tecniche: trecce e corde di rame <i>Technical characteristics: braids and rope</i> _____	3
	Corda in rame con isolamento siliconico RHO e SYL <i>Silicone insulated copper cable RHO and SYL</i> _____	6
	Collegamenti flessibili in treccia con isolamento siliconico RHO <i>Braided shunts with silicone RHO insulation</i> _____	8
	Collegamenti flessibili in treccia con isolamento siliconico SYL <i>Braided shunts with silicone SYL insulation</i> _____	10
	Collegamenti flessibili in treccia isolati HT105 <i>Braided shunts with HT105 insulation</i> _____	12
	Trecce di massa <i>Earthing braids</i> _____	14
	Collegamenti in treccia piatta <i>Flat braided shunts</i> _____	15
	Flessibili per forti intensità con terminali larghi <i>High current shunts for large transformer links</i> _____	17
	Flessibili per forti intensità ad attacco contenuto <i>High current shunt with reduced terminals</i> _____	18
	Flessibili in treccia rotonda o corda <i>Round braided shunts</i> _____	21
	Flessibili raffreddati ad aria <i>Air cooled high current cables</i> _____	22
	Trecce di massa rotonde <i>Round grounding strips</i> _____	23
	Trecce di massa in alluminio <i>Aluminium earthing straps</i> _____	24
	Lamellari pressosaldati <i>Press welded shunts</i> _____	25
	Barre flessibili <i>Flexible bars</i> _____	30
	Isolatori <i>Spacers insulators</i> _____	33
	Bandelle di rame <i>Busbars - solid bars</i> _____	34
	Informazioni tecniche <i>Technical information</i> _____	35

# TRECCE E CORDE

## BRAIDED COPPER STRIPS AND TWISTED CABLES

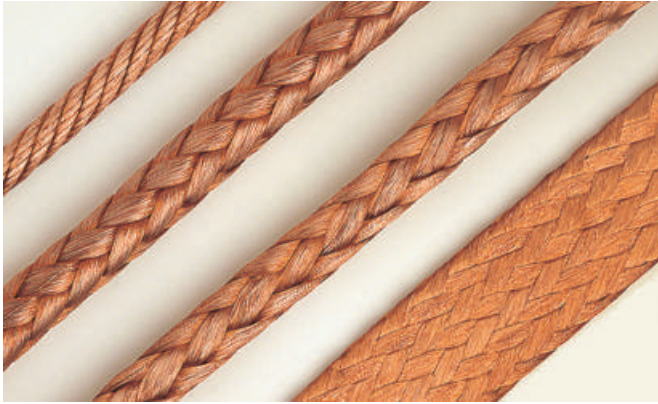

**Sezione reale:** è la somma delle sezioni dei fili elementari.

**Sezione apparente:** è la sezione risultante dalle dimensioni esterne della treccia, e corrisponde all'incirca al doppio della sezione reale.

**Flessibilità:** dipende essenzialmente dalla resistenza meccanica del materiale utilizzato e dal suo diametro. L'impiego elettrico richiede di norma rame elettrolitico ricotto, rosso oppure stagnato.

**Extra flessibile ES:** filo elementare 0,05-0,07

**Flessibilissima S:** filo elementare 0,10

**Molto flessibile ST:** filo elementare 0,15

**Flessibile EF:** filo elementare 0,20

**Semi flessibile F:** filo elementare 0,25-0,30

**Real cross-sectional area:** can be obtained by adding all the cross-sectional areas of each wire that make up the strip or braid.

**Apparent cross-sectional area:** is equal to the resultant area of the external dimensions of the braid, and it is equal to about twice of the real cross-sectional area.

**Flexibility:** depends essentially on the mechanical resistance of the material used and on its diameter. Usually, electrical applications require annealed electrolytic copper, red or tinned.

**Highly flexible "ES":** single strand wire with a diameter of 0.05 to 0.07

**Very very flexible "S":** single strand wire with a diameter of 0.10

**Very flexible "ST":** single strand wire with a diameter of 0.15

**Flexible "EF":** single strand wire with a diameter of 0.20

**Semi flexible "F":** single strand wire with a diameter of 0.25 to 0.30

### CARATTERISTICHE DELLE TRECCE | CHARACTERISTICS OF BRAIDS

TIPO   TYPE	DEFINIZIONE   DEFINITION	VANTAGGI   ADVANTAGES	SVANTAGGI   DISADVANTAGES
<b>CORDA TWISTED CABLE</b>	I trefoli sono avvolti ad elica. Il passo condiziona la flessibilità della corda. <i>The strands are wound like a propeller. Its flexibility is determined by its winding pitch.</i>	Aspetto esterno perfettamente cilindrico. Disponibile in pezzature molto lunghe senza giunti. Costo di produzione molto contenuto. Flessibilità in tutti i sensi. <i>External appearance is a perfect cylinder. Available in very long pieces without shunts. Low production costs. Flexible in every respect.</i>	Non ammette la torsione, incrudimento del materiale se la torsione è nel senso dell'elica, allargamento con rischio di scordatura nel senso contrario. Allargamento dei trefoli nelle curvature, scordatura durante il taglio. <i>Does not accept torsion, work hardening, if the torsion is in the propeller's direction, widening and risk of breakage if torsion is in the opposite direction. Strands may become wider when curved, separation of strands when the strip is cut.</i>
<b>TRECCE ROTONDE ROUND BRAID</b>	I trefoli sono trecciati ad eliche contrarie. Il passo di trecciatura influenza la flessibilità. <i>The strands are wound like propellers but in opposite direction. The winding pitch determines flexibility.</i>	Estrema flessibilità, superiore alle corde di pari sezione e filo elementare. Buona tenuta delle estremità durante il taglio. Flessibilità in tutte le direzioni. Torsione senza l'allargamento dei trefoli. Si possono ottenere sezioni quadrate a spigoli arrotondati oppure rettangolari con buona flessibilità di piatto. <i>Extreme flexibility, more flexible than braids of equal cross-sectional area and than single stranded wires: when this type of braid is cut the strands do not separate. Flexible in all directions. Resists torsion to the point that the strands do not widen. Square or rectangular sections with round edges can be obtained, with a good flat flexibility.</i>	Non perfettamente cilindrica. Non si possono ottenere grandi lunghezze, prezzo più elevato rispetto alle corde. <i>Not a perfect cylinder. Great lengths cannot be obtained, higher costs with respect to the braid type.</i>
<b>TRECCE PIATTE FLAT BRAID</b>	I trefoli sono trecciati ad eliche contrarie. Presentano una sezione rettangolare di spessore modesto. <i>The strands are wound like propellers but in opposite direction. Its cross-section is rectangular and not extremely thick.</i>	Grandissima flessibilità di piatto. Spessore contenuto rispetto alla larghezza. Si possono ottenere forti sezioni con sovrapposizione di più trecce. <i>Great flat flexibility. Thickness is within limits with respect to its width. Strong sections can be made by overlapping many strips.</i>	Sezioni limitate. Scarsa flessibilità di costa. Limitata tenuta dei collegamenti ottenuti per sovrapposizione di più trecce che si contrastano a vicenda durante le flessioni. <i>Limited sections. Low lateral flexibility. Limited connection tightness due to overlapping of strips which oppose each other when flexing occurs.</i>
<b>TRECCE TUBULARI APPIATTITE FLAT TUBULAR TYPE BRAID</b>	I trefoli sono trecciati ad eliche contrarie con forma tubulare. Vengono laminati per ottenere la forma rettangolare. È la treccia più utilizzata. <i>The strands are wound like propellers but in opposite direction and tubular shape. They are laminated in order to take on a rectangular shape. This is the most commonly used braid.</i>	Grandissima flessibilità di piatto. Si possono ottenere grandi spessori in rapporto alla larghezza. Possibilità di ottenere forti sezioni con una sola treccia o grandi sezioni con più trecce a coperture successive. <i>Great flat flexibility. They can be made very thick with respect to its width. Strong sections can be made by using only one braid or big sections can be made by using many successive braids.</i>	Cattiva flessibilità di costa. <i>Poor lateral flexibility.</i>

I valori delle portate sono dati a titolo di informazione e valgono per trecce e corde lucide disposte orizzontalmente. I valori reali si possono scostare sensibilmente da quelli tabellati poiché dipendono oltremodo dalla formazione, numero e diametro dei fili elementari, dimensioni esterne delle trecce o diametro delle corde.

The current flow values are provided for information and are true for braids and twisted cables, which are used horizontally. The real values may stray within tolerance, from the values reported in the table, because it depends on the braid's or cable's composition, i.e. number and diameter of the single strands of wire, external diameter of the cable or external dimensions of the braid.

### CORRENTI MASSIME AMMISSIBILI PER TRECCE E CORDE IN RAME RICOTTO MAXIMUM ALLOWABLE CURRENT FLOW FOR ANNEALED BRAIDS AND TWISTED CABLES

Sezione nominale mm. Nominal cross-section in mm.	1	1,5	2,5	4	6	10	16	25	35	50	70	100	150	200	250	300	400	500	600	800	1000	1200	1500	2000	2500	3000
Corrente massima ammissibile A Maximum allowable current in A.	18	21	30	40	55	85	120	150	195	250	300	370	480	610	700	780	950	1100	1250	1500	1800	2000	2200	2400	2750	3000

Le portate si riferiscono alla temperatura ambiente di 35°C sulla base della temperatura massima ammessa sul conduttore di 70°C. I valori indicati non possono implicare in nessun caso la responsabilità del costruttore.

The values which are shown in the table below are to be considered at a room temperature of 35°C (95°F) and the maximum operating temperature shall be 70°C (158°F). The manufacturer is not responsible, under any circumstance for the values reported in the table above.

# TRECCIA TUBOLARE APPIATTITA

## FLAT BRAIDS LAMINATED TUBES

Cu ETP UNI EN 1977-78:2000

RAME ROSSO   BARE COPPER							
Sezione mm <sup>2</sup> Section	Filo elem. 0,05 mm. Ø of wire	Filo elem. 0,07 mm. Ø of wire	Filo elem. 0,10 mm. Ø of wire	Filo elem. 0,15 mm. Ø of wire	Filo elem. 0,20 mm. Ø of wire	Dimensioni mm. dimensions	Peso Kg/mt. Weight
1	CR 1-005/3	CR 1-007/3	CR 1-010/3			3 x 0,7	0,010
1,5	CR 1,5-005/5	CR 1,5-007/5	CR 1,5-010/5			5 x 0,6	0,015
2,5	CR 2,5-005/7	CR 2,5-007/7	CR 2,5-010/7			7 x 0,7	0,025
4	CR 4-005/8	CR 4-007/8	CR 4-010/8	CR 4-015/8	CR 4-020/8	8 x 1,0	0,04
6	CR 6-005/10	CR 6-007/10	CR 6-010/10	CR 6-015/10	CR 6-020/10	10 x 1,2	0,06
10	CR 10-005/15	CR 10-007/15	CR 10-010/15	CR 10-015/15	CR 10-020/15	15 x 1,3	0,10
16	CR 16-005/15	CR 16-007/15	CR 16-010/15	CR 16-015/15	CR 16-020/15	15 x 2,1	0,16
20	CR 20-005/20	CR 20-007/20	CR 20-010/20	CR 20-015/20	CR 20-020/20	20 x 2,0	0,20
25	CR 25-005/20	CR 25-007/20	CR 25-010/20	CR 25-015/20	CR 25-020/20	20 x 2,5	0,25
30	CR 30-005/20	CR 30-007/20	CR 30-010/20	CR 30-015/20	CR 30-020/20	20 x 3,0	0,30
35	CR 35-005/20	CR 35-007/20	CR 35-010/20	CR 35-015/20	CR 35-020/20	20 x 3,5	0,35
50	CR 50-005/28	CR 50-007/28	CR 50-010/28	CR 50-015/28	CR 50-020/28	28 x 3,6	0,50
75			CR 75-010/28	CR 75-015/28	CR 75-020/28	28 x 5,4	0,75
100			CR 100-010/33	CR 100-015/33	CR 100-020/33	33 x 6,1	1,00
120			CR 120-010/35	CR 120-015/35	CR 120-020/35	35 x 6,8	1,20
150			CR 150-010/38	CR 150-015/38	CR 150-020/38	38 x 7,9	1,50
200			CR 200-010/40	CR 200-015/40	CR 200-020/40	40 x 10,0	2,00
250			CR 250-010/40	CR 250-015/40	CR 250-020/40	40 x 12,5	2,50
300			CR 300-010/50	CR 300-015/50	CR 300-020/50	50 x 12,0	3,00
400			CR 400-010/60	CR 400-015/60	CR 400-020/60	60 x 13,0	4,00
500			CR 500-010/95	CR 500-015/95	CR 500-020/95	95 x 10,5	5,00
600			CR 600-010/95	CR 600-015/95	CR 600-020/95	95 x 12,6	6,00
800			CR 800-010/100	CR 800-015/100	CR 800-020/100	100 x 16,0	8,00
1000			CR 1000-010/100	CR 1000-015/100	CR 1000-020/100	100 x 20,0	10,00

# TRECCIA TUBOLARE APPIATTITA

## FLAT BRAIDS LAMINATED TUBES

Cu ETP UNI EN 1977-78:2000

RAME STAGNATO   TINNED COPPER							
Sezione mm <sup>2</sup> Section	Filo elem. 0,05 mm. Ø of wire	Filo elem. 0,07 mm. Ø of wire	Filo elem. 0,10 mm. Ø of wire	Filo elem. 0,15 mm. Ø of wire	Filo elem. 0,20 mm. Ø of wire	Dimensioni mm. dimensions	Peso Kg/mt. Weight
1		CS 1-007/3	CS 1-010/3			3 x 0,7	0,010
1,5		CS 1,5-007/5	CS 1,5-010/5			5 x 0,6	0,015
2,5		CS 2,5-007/7	CS 2,5-010/7			7 x 0,7	0,025
4		CS 4-007/8	CS 4-010/8	CS 4-015/8	CS 4-020/8	8 x 1,0	0,04
6		CS 6-007/10	CS 6-010/10	CS 6-015/10	CS 6-020/10	10 x 1,2	0,06
10		CS 10-007/15	CS 10-010/15	CS 10-015/15	CS 10-020/15	15 x 1,3	0,10
16		CS 16-007/15	CS 16-010/15	CS 16-015/15	CS 16-020/15	15 x 2,1	0,16
20		CS 20-007/20	CS 20-010/20	CS 20-015/20	CS 20-020/20	20 x 2,0	0,20
25		CS 25-007/20	CS 25-010/20	CS 25-015/20	CS 25-020/20	20 x 2,5	0,25
30		CS 30-007/20	CS 30-010/20	CS 30-015/20	CS 30-020/20	20 x 3,0	0,30
35		CS 35-007/20	CS 35-010/20	CS 35-015/20	CS 35-020/20	20 x 3,5	0,35
50		CS 50-007/28	CS 50-010/28	CS 50-015/28	CS 50-020/28	28 x 3,6	0,50
75			CS 75-010/28	CS 75-015/28	CS 75-020/28	28 x 5,4	0,75
100			CS 100-010/33	CS 100-015/33	CS 100-020/33	33 x 6,1	1,00
120			CS 120-010/35	CS 120-015/35	CS 120-020/35	35 x 6,8	1,20
150			CS 150-010/38	CS 150-015/38	CS 150-020/38	38 x 7,9	1,50
200			CS 200-010/40	CS 200-015/40	CS 200-020/40	40 x 10,0	2,00
250			CS 250-010/40	CS 250-015/40	CS 250-020/40	40 x 12,5	2,50
300			CS 300-010/50	CS 300-015/50	CS 300-020/50	50 x 12,0	3,00
400			CS 400-010/60	CS 400-015/60	CS 400-020/60	60 x 13,0	4,00
500			CS 500-010/95	CS 500-015/95	CS 500-020/95	95 x 10,5	5,00
600			CS 600-010/95	CS 600-015/95	CS 600-020/95	95 x 12,6	6,00
800			CS 800-010/100	CS 800-015/100	CS 800-020/100	100 x 16,0	8,00
1000			CS 1000-010/100	CS 1000-015/100	CS 1000-020/100	100 x 20,0	10,00

ALLESTIMENTI SU RICHIESTA: formazioni non comprese in tabella | ON REQUEST: other sizes of braids not shown above.

# TRECCIA ROTONDA | ROUND BRAIDS

Cu ETP UNI EN 1977-78:2000

Material: E Copper bare or tinned

ROTONDA   ROUND BRAID								
Sezione mm <sup>2</sup> Section	Extra flessibile   Highly flexible Filo elem. 0,05 mm. Ø of wire		Flessibilissima   Very very flexible Filo elem. 0,10 mm. Ø of wire		Flessibile   Flexible Filo elem. 0,20 mm. Ø of wire		Ø mm.	Peso Weight Kg/mt.
	RAME ROSSO RED COPPER	RAME STAGNATO TINNED COPPER	RAME ROSSO RED COPPER	RAME STAGNATO TINNED COPPER	RAME ROSSO RED COPPER	RAME STAGNATO TINNED COPPER		
1	COR 1-0,05		COR 1-0,10	COS 1-0,10	COR 1-0,20	COS 1-0,20	1,3	0,010
1,5	COR 1,5-0,05		COR 1,5-0,10	COS 1,5-0,10	COR 1,5-0,20	COS 1,5-0,20	1,6	0,015
2	COR 2-0,05		COR 2-0,10	COS 2-0,10	COR 2-0,20	COS 2-0,20	2,1	0,020
2,5	COR 2,5-0,05		COR 2,5-0,10	COS 2,5-0,10	COR 2,5-0,20	COS 2,5-0,20	2,2	0,025
3	COR 3-0,05		COR 3-0,10	COS 3-0,10	COR 3-0,20	COS 3-0,20	2,6	0,030
4	COR 4-0,05		COR 4-0,10	COS 4-0,10	COR 4-0,20	COS 4-0,20	2,9	0,040
6	COR 6-0,05		COR 6-0,10	COS 6-0,10	COR 6-0,20	COS 6-0,20	3,8	0,060
8	COR 8-0,05		COR 8-0,10	COS 8-0,10	COR 8-0,20	COS 8-0,20	4,3	0,080
10	COR 10-0,05		COR 10-0,10	COS 10-0,10	COR 10-0,20	COS 10-0,20	4,8	0,100
16	COR 16-0,05		COR 16-0,10	COS 16-0,10	COR 16-0,20	COS 16-0,20	6	0,160
20	COR 20-0,05		COR 20-0,10	COS 20-0,10	COR 20-0,20	COS 20-0,20	7	0,200
25	COR 25-0,05		COR 25-0,10	COS 25-0,10	COR 25-0,20	COS 25-0,20	7,5	0,250
30	COR 30-0,05		COR 30-0,10	COS 30-0,10	COR 30-0,20	COS 30-0,20	8,5	0,300
35	COR 35-0,05		COR 35-0,10	COS 35-0,10	COR 35-0,20	COS 35-0,20	9,4	0,350
50	COR 50-0,05		COR 50-0,10	COS 50-0,10	COR 50-0,20	COS 50-0,20	11	0,500
60			COR 60-0,10	COS 60-0,10	COR 60-0,20	COS 60-0,20	12	0,600
75			COR 75-0,10	COS 75-0,10	COR 75-0,20	COS 75-0,20	13,5	0,750
100			COR 100-0,10	COS 100-0,10	COR 100-0,20	COS 100-0,20	16	1,000
150			COR 150-0,10	COS 150-0,10	COR 150-0,20	COS 150-0,20	19,5	1,500

# CORDA | TWISTED CABLES (ROPE)

Cu ETP UNI EN 1977-78:2000

ROTONDA   ROUND BRAID								
Sezione mm <sup>2</sup> Section	Extra flessibile   Highly flexible Filo elem. 0,05 mm. Ø of wire		Flessibilissima   Very very flexible Filo elem. 0,10 mm. Ø of wire		Flessibile   Flexible Filo elem. 0,20 mm. Ø of wire		Ø mm.	Peso Weight Kg/mt.
	RAME ROSSO RED COPPER	RAME STAGNATO TINNED COPPER	RAME ROSSO RED COPPER	RAME STAGNATO TINNED COPPER	RAME ROSSO RED COPPER	RAME STAGNATO TINNED COPPER		
0,5	CCR 0,5-0,05						1	0,005
1	CCR 1-0,05		CCR 1-0,10	CCS 1-0,10			1,5	0,010
1,5	CCR 1,5-0,05		CCR 1,5-0,10	CCS 1,5-0,10			2	0,015
2	CCR 2-0,05		CCR 2-0,10	CCS 2-0,10			2,3	0,020
2,5	CCR 2,5-0,05		CCR 2,5-0,10	CCS 2,5-0,10			2,5	0,025
4	CCR 4-0,05		CCR 4-0,10	CCS 4-0,10	CCR 4-0,20	CCS 4-0,20	3,1	0,041
5	CCR 5-0,05		CCR 5-0,10	CCS 5-0,10	CCR 5-0,20	CCS 5-0,20	3,5	0,052
6	CCR 6-0,05		CCR 6-0,10	CCS 6-0,10	CCR 6-0,20	CCS 6-0,20	4	0,062
8	CCR 8-0,05		CCR 8-0,10	CCS 8-0,10	CCR 8-0,20	CCS 8-0,20	4,5	0,083
10	CCR 10-0,05		CCR 10-0,10	CCS 10-0,10	CCR 10-0,20	CCS 10-0,20	5	0,105
15	CCR 15-0,05		CCR 15-0,10	CCS 15-0,10	CCR 15-0,20	CCS 15-0,20	6,5	0,155
16	CCR 16-0,05		CCR 16-0,10	CCS 16-0,10	CCR 16-0,20	CCS 16-0,20	6,6	0,165
20	CCR 20-0,05		CCR 20-0,10	CCS 20-0,10	CCR 20-0,20	CCS 20-0,20	7,1	0,205
25	CCR 25-0,05		CCR 25-0,10	CCS 25-0,10	CCR 25-0,20	CCS 25-0,20	7,6	0,255
30	CCR 30-0,05		CCR 30-0,10	CCS 30-0,10	CCR 30-0,20	CCS 30-0,20	8,8	0,305
35	CCR 35-0,05		CCR 35-0,10	CCS 35-0,10	CCR 35-0,20	CCS 35-0,20	9,5	0,355
40	CCR 40-0,05		CCR 40-0,10	CCS 40-0,10	CCR 40-0,20	CCS 40-0,20	10,3	0,405
50	CCR 50-0,05		CCR 50-0,10	CCS 50-0,10	CCR 50-0,20	CCS 50-0,20	11,5	0,525
60			CCR 60-0,10	CCS 60-0,10	CCR 60-0,20	CCS 60-0,20	13	0,620
70			CCR 70-0,10	CCS 70-0,10	CCR 70-0,20	CCS 70-0,20	13,5	0,700
100			CCR 100-0,10	CCS 100-0,10	CCR 100-0,20	CCS 100-0,20	16	1,100
120			CCR 120-0,10	CCS 120-0,10	CCR 120-0,20	CCS 120-0,20	17,5	1,250
150			CCR 150-0,10	CCS 150-0,10	CCR 150-0,20	CCS 150-0,20	19	1,550
200			CCR 200-0,10	CCS 200-0,10	CCR 200-0,20	CCS 200-0,20	24	2,180
250			CCR 250-0,10	CCS 250-0,10	CCR 250-0,20	CCS 250-0,20	26,5	2,650
300			CCR 300-0,10	CCS 300-0,10	CCR 300-0,20	CCS 300-0,20	28	3,150
400			CCR 400-0,10	CCS 400-0,10	CCR 400-0,20	CCS 400-0,20	32	4,000
500			CCR 500-0,10	CCS 500-0,10	CCR 500-0,20	CCS 500-0,20	34	5,000
600			CCR 600-0,10	CCS 600-0,10	CCR 600-0,20	CCS 600-0,20	36	6,000
700			CCR 700-0,10	CCS 700-0,10	CCR 700-0,20	CCS 700-0,20	38	7,000
800			CCR 800-0,10	CCS 800-0,10	CCR 800-0,20	CCS 800-0,20	41	8,000
1000			CCR 1000-0,10	CCS 1000-0,10	CCR 1000-0,20	CCS 1000-0,20	46	10,000

ALLESTIMENTI SU RICHIESTA: Filo elementare 0,07 - 0,15. Altre formazioni non comprese in tabella  
ON REQUEST: other sizes of braids not shown above.

# CORDA IN RAME ROSSO O STAGNATO con isolamento siliconico RHO - lunghezza 6m

## SILICONE INSULATED COPPER CABLE - RHO bare or tinned wire - 6 meters length

- ▶ Estremamente flessibile | *Extremely flexible*
- ▶ Senza alogeni, autoestinguente UL94V0  
*Free of halogen and flame retardant UL94V0*
- ▶ Elementi da 6 metri | *Cable deliverable on rolls of 6 meters*
- ▶ Filo elementare | *Single wire* Cu ETP UNI EN 1977-78:2000  
0,20 standard  
0,10 su richiesta | *on request*

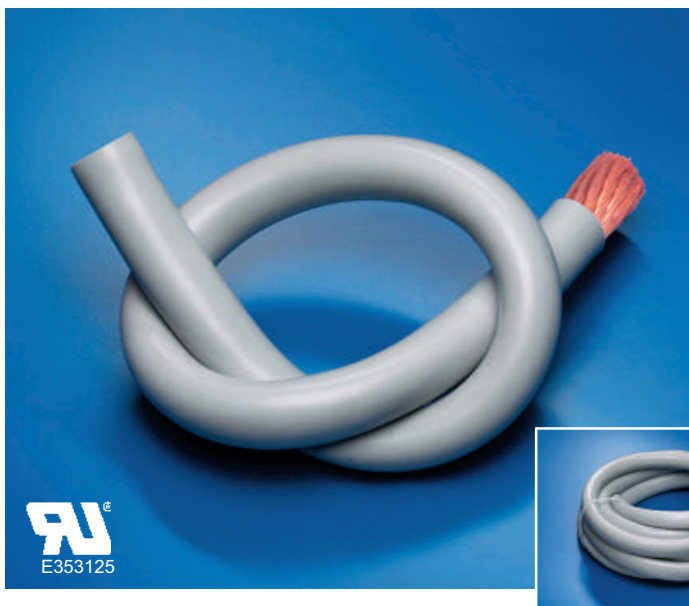

Rame Rosso <i>Red Copper</i>	Rame Stagnato <i>Tinned Copper</i>	Sezione mm <sup>2</sup> <i>Section</i>	Ø Filo <i>Wire dia.</i>	Ø mm	Portata max AC Amps <i>Ampacity</i>	Peso <i>Weight</i> kg/mt
CCR 50/020 RHO	CCS 50/020 RHO	50	0,20	15	250	0,60
CCR 70/020 RHO	CCS 70/020 RHO	70	0,20	17	300	0,80
CCR 100/020 RHO	CCS 100/020 RHO	100	0,20	20	350	1,15
CCR 120/020 RHO	CCS 120/020 RHO	120	0,20	22	400	1,35
CCR 150/020 RHO	CCS 150/020 RHO	150	0,20	24	500	1,70
CCR 200/020 RHO	CCS 200/020 RHO	200	0,20	28	550	2,20
CCR 240/020 RHO	CCS 240/020 RHO	240	0,20	30	630	2,65
CCR 300/020 RHO	CCS 300/020 RHO	300	0,20	32	700	3,25

### CARATTERISTICHE ISOLANTE SILICONICO RHO:

### SILICONE INSULATION CHARACTERISTICS:

#### MESCOLA SILICONICA REASIL Serie ME122

autoestinguente UL94V0 a bassa opacità e tossicità dei fumi secondo specifica FS 304142.

Colore dell'isolante	grigio
Temperatura massima	+250°C
Temperatura minima	-50°C
Tensione nominale	1000 V AC - 1500 V DC
Spessore della guaina	2 mm
Rigidità dielettrica	>21 Kv/mm
Reazione al fuoco CSE	classe 1
Determinazione classe di fumo	F1

#### SILICON - REASIL Serie ME122

Low toxic fumes, opaque and self extinguishing UL94V0 in accordance with FS 304142 specification.

Insulation colour	grey
Maximum temperature	+250°C
Minimum temperature	-50°C
Operating voltage	1000 V AC - 1500 V DC
Sleeve thick	2 mm
Dielectric strength	>21 Kv/mm
Reaction to fire (CSE)	class 1
Smoke class determination	F1

#### Prodotto | *Product*

#### RHO REASIL Serie ME122

#### Requisiti | *Requirements*

#### R22 - R23

#### Prove richieste | *Test required*

#### EN ISO 4589-2

#### EN ISO 5659-2

#### NF X 70-100-1/-2

#### Parametro | *Parameter*

LOI (%)

(25 Kw/m<sup>2</sup> - Flaming) Ds max

CIT

#### Valori trovati | *Values found*

33.5

137

0.10

Per | For

Per | For

Per | For

#### Limiti di accettazione

#### *Acceptance limits*

#### R22 - R23

HL1: ≥ 28%

HL2: ≥ 28%

HL3: ≥ 32%

#### R22

HL1: ≤ 600

HL2: ≤ 300

HL3: ≤ 150

#### R23

HL1: ---

HL2: ≤ 600

HL3: ≤ 300

#### R22

HL1: ≤ 1.2

HL2: ≤ 0.9

HL3: ≤ 0.75

#### R23

HL1: ---

HL2: ≤ 1.8

HL3: ≤ 1.5

Il materiale è CONFORME alle richieste UNI EN 45545-2:2015 per livelli di rischio HL1 - HL2 - HL3 per set di requisiti R22 e R23.

*The materials COMPLIES with the requirements of UNI EN 45545-2:2015 for Hazard Levels HL-1 - HL2 - HL3 for requirements set R22 and R23*

# CORDA IN RAME ROSSO O STAGNATO con isolamento siliconico SYL - lunghezza 6m

## SILICONE INSULATED COPPER CABLE - SYL bare or tinned wire - 6 meters length

- ▶ Estremamente flessibile | *Extremely flexible*
- ▶ Senza alogeni, autoestinguente UL94V1  
*Free of halogen and flame retardant UL94V1*
- ▶ Elementi da 6 metri | *Cable deliverable on rolls of 6 meters*
- ▶ Filo elementare | *Single wire* Cu ETP UNI EN 1977-78:2000  
0,20 standard  
0,10 su richiesta | *on request*



**RU**  
E353125

Rame Rosso <i>Red Copper</i>	Rame Stagnato <i>Tinned Copper</i>	Sezione mm <sup>2</sup> <i>Section</i>	Ø Filo <i>Wire dia.</i>	Ø mm	Portata max AC Amps <i>Ampacity</i>	Peso <i>Weight</i> kg/mt
CCR 50/020 SYL	CCS 50/020 SYL	50	0,20	15	250	0,60
CCR 70/020 SYL	CCS 70/020 SYL	70	0,20	17	300	0,80
CCR 100/020 SYL	CCS 100/020 SYL	100	0,20	20	350	1,15
CCR 120/020 SYL	CCS 120/020 SYL	120	0,20	22	400	1,35
CCR 150/020 SYL	CCS 150/020 SYL	150	0,20	24	500	1,70
CCR 200/020 SYL	CCS 200/020 SYL	200	0,20	28	550	2,20
CCR 240/020 SYL	CCS 240/020 SYL	240	0,20	30	630	2,65
CCR 300/020 SYL	CCS 300/020 SYL	300	0,20	32	700	3,25

### CARATTERISTICHE ISOLANTE SILICONICO SYL:

#### MESCOLA SILICONICA VMQ60PT nero

autoestinguente a bassa opacità e tossicità dei fumi secondo specifica FS 304142.

Colore dell'isolante	nero
Temperatura massima	+200°C
Temperatura minima	-50°C
Tensione nominale	660 V AC - 1000 V DC
Spessore minimo della guaina	1,5 mm
Rigidità dielettrica	>21 Kv/mm
Reazione al fuoco CSE	classe 1
Determinazione classe di fumo	F1

### SILICONE INSULATION CHARACTERISTICS:

#### SILICON - VMQ60PT black

Low toxic fumes, opaque and self extinguishing in accordance with FS 304142 specification.

Insulation colour	black
Maximum temperature	+200°C
Minimum temperature	-50°C
Operating voltage	660 V AC - 1000 V DC
Minimum sleeve thick	1.5 mm
Dielectric strength	>21 Kv/mm
Reaction to fire (CSE)	class 1
Smoke class determination	F1

### Specifica tecnica miscela: VMQ60PT nero

POST-CURING: vulcanizzazione completata in forno per 4h a 200°C

Codice capitolato richiesto: VMQ (-55°C / +200°C)	Metodo di prova	Richiesto	Rilevato	Garantito	Unità di misura
Durezza	ASTM D 2240 3s		60	60 ± 5	SHORE A
Densità	ISO 2781 A		1,16	1,16 ± 0,03	g/cm <sup>2</sup>
Carico di rottura	ISO 37 - Tipo 2		9,8		N/mm <sup>2</sup>
Allungamento a rottura	ISO 37 - Tipo 2		590		%
Modulo al 100%	ISO 37 - Tipo 2		1,6		N/mm <sup>2</sup>
Compression set	ISO 815A	dopo 22h a 175°C	31		%
Lacerazione	ISO 34-1 B (b)		31		N/mm <sup>2</sup>

### Variazioni delle caratteristiche

Ambiente	Metodo	Tempo	Temp.	Durezza Δ	Carico a rottura Δ %	Allungam. a rottura Δ %	Volume Δ %	Peso Δ %
		ore	°C	Ric. Ril.	Ric. Ril.	Ric. Ril.	Ric. Ril.	Ric. Ril.
Aria	ISO 188 B	70	200		+4		-30	

# COLLEGAMENTI FLESSIBILI IN TRECCIA PIATTA con isolamento silicico RHO

## FLAT BRAIDED SHUNTS with silicone insulation RHO

► Terminali in tubo di rame stagnato  
Pressed copper  
connectors, tin coated

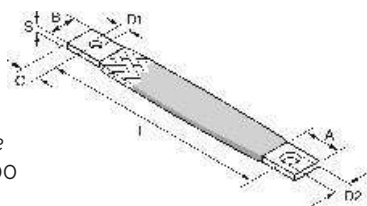

► Filo elementare | Single wire  
Cu ETP UNI EN 1977-78:2000  
0,20 standard  
0,10 su richiesta | on request

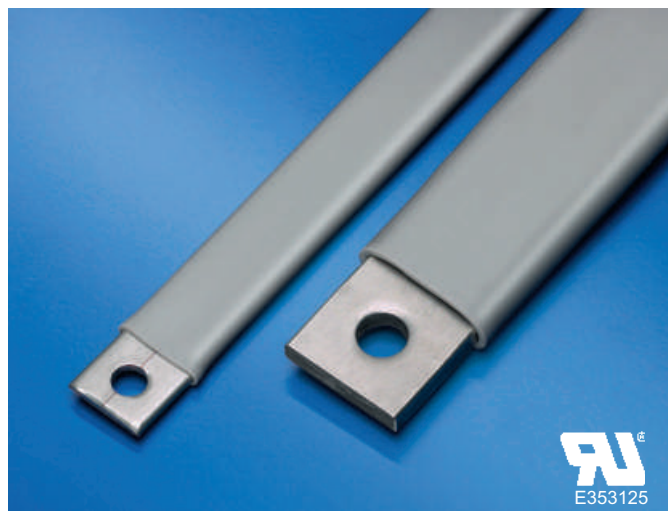

**AI**  
E353125

Rame Rosso Red Copper	Rame Stagnato Tinned Copper	Sezione mm <sup>2</sup> Section	Ø Filo Wire dia.	A mm.	B mm.	C mm.	D1 mm.	D2 mm.	S mm.	L mm.	Portata max AC Amps Ampacity
CRS 25-150 / 20 RHO	CSS 25-150 / 20 RHO	25	0,20	20	20	10	9	9	3,2	150	160
CRS 25-200 / 20 RHO	CSS 25-200 / 20 RHO	25	0,20	20	20	10	9	9	3,2	200	160
CRS 25-250 / 20 RHO	CSS 25-250 / 20 RHO	25	0,20	20	20	10	9	9	3,2	250	160
CRS 25-300 / 20 RHO	CSS 25-300 / 20 RHO	25	0,20	20	20	10	9	9	3,2	300	160
CRS 25-400 / 20 RHO	CSS 25-400 / 20 RHO	25	0,20	20	20	10	9	9	3,2	400	160
CRS 25-500 / 20 RHO	CSS 25-500 / 20 RHO	25	0,20	20	20	10	9	9	3,2	500	160
CRS 25-600 / 20 RHO	CSS 25-600 / 20 RHO	25	0,20	20	20	10	9	9	3,2	600	160
CRS 35-150 / 20 RHO	CSS 35-150 / 20 RHO	35	0,20	20	20	10	9	9	3,4	150	200
CRS 35-200 / 20 RHO	CSS 35-200 / 20 RHO	35	0,20	20	20	10	9	9	3,4	200	200
CRS 35-250 / 20 RHO	CSS 35-250 / 20 RHO	35	0,20	20	20	10	9	9	3,4	250	200
CRS 35-300 / 20 RHO	CSS 35-300 / 20 RHO	35	0,20	20	20	10	9	9	3,4	300	200
CRS 35-400 / 20 RHO	CSS 35-400 / 20 RHO	35	0,20	20	20	10	9	9	3,4	400	200
CRS 35-500 / 20 RHO	CSS 35-500 / 20 RHO	35	0,20	20	20	10	9	9	3,4	500	200
CRS 35-600 / 20 RHO	CSS 35-600 / 20 RHO	35	0,20	20	20	10	9	9	3,4	600	200
CRS 50-150 / 25 RHO	CSS 50-150 / 25 RHO	50	0,20	25	25	12,5	11	11	4,5	150	250
CRS 50-200 / 25 RHO	CSS 50-200 / 25 RHO	50	0,20	25	25	12,5	11	11	4,5	200	250
CRS 50-250 / 25 RHO	CSS 50-250 / 25 RHO	50	0,20	25	25	12,5	11	11	4,5	250	250
CRS 50-300 / 25 RHO	CSS 50-300 / 25 RHO	50	0,20	25	25	12,5	11	11	4,5	300	250
CRS 50-400 / 25 RHO	CSS 50-400 / 25 RHO	50	0,20	25	25	12,5	11	11	4,5	400	250
CRS 50-500 / 25 RHO	CSS 50-500 / 25 RHO	50	0,20	25	25	12,5	11	11	4,5	500	250
CRS 50-600 / 25 RHO	CSS 50-600 / 25 RHO	50	0,20	25	25	12,5	11	11	4,5	600	250
CRS 75-150 / 30 RHO	CSS 75-150 / 30 RHO	75	0,20	30	30	15	11	11	5,0	150	300
CRS 75-200 / 30 RHO	CSS 75-200 / 30 RHO	75	0,20	30	30	15	11	11	5,0	200	300
CRS 75-250 / 30 RHO	CSS 75-250 / 30 RHO	75	0,20	30	30	15	11	11	5,0	250	300
CRS 75-300 / 30 RHO	CSS 75-300 / 30 RHO	75	0,20	30	30	15	11	11	5,0	300	300
CRS 75-400 / 30 RHO	CSS 75-400 / 30 RHO	75	0,20	30	30	15	11	11	5,0	400	300
CRS 75-500 / 30 RHO	CSS 75-500 / 30 RHO	75	0,20	30	30	15	11	11	5,0	500	300
CRS 75-600 / 30 RHO	CSS 75-600 / 30 RHO	75	0,20	30	30	15	11	11	5,0	600	300
CRS 100-200 / 35 RHO	CSS 100-200 / 35 RHO	100	0,20	35	35	15	11	11	5,6	200	350
CRS 100-250 / 35 RHO	CSS 100-250 / 35 RHO	100	0,20	35	35	15	11	11	5,6	250	350
CRS 100-300 / 35 RHO	CSS 100-300 / 35 RHO	100	0,20	35	35	15	11	11	5,6	300	350
CRS 100-350 / 35 RHO	CSS 100-350 / 35 RHO	100	0,20	35	35	15	11	11	5,6	350	350
CRS 100-400 / 35 RHO	CSS 100-400 / 35 RHO	100	0,20	35	35	15	11	11	5,6	400	350
CRS 100-500 / 35 RHO	CSS 100-500 / 35 RHO	100	0,20	35	35	15	11	11	5,6	500	350
CRS 100-600 / 35 RHO	CSS 100-600 / 35 RHO	100	0,20	35	35	15	11	11	5,6	600	350
CRS 120-200 / 35 RHO	CSS 120-200 / 35 RHO	120	0,20	35	35	15	11	11	6,5	200	400
CRS 120-250 / 35 RHO	CSS 120-250 / 35 RHO	120	0,20	35	35	15	11	11	6,5	250	400
CRS 120-300 / 35 RHO	CSS 120-300 / 35 RHO	120	0,20	35	35	15	11	11	6,5	300	400
CRS 120-350 / 35 RHO	CSS 120-350 / 35 RHO	120	0,20	35	35	15	11	11	6,5	350	400
CRS 120-400 / 35 RHO	CSS 120-400 / 35 RHO	120	0,20	35	35	15	11	11	6,5	400	400
CRS 120-500 / 35 RHO	CSS 120-500 / 35 RHO	120	0,20	35	35	15	11	11	6,5	500	400
CRS 120-600 / 35 RHO	CSS 120-600 / 35 RHO	120	0,20	35	35	15	11	11	6,5	600	400
CRS 150-200 / 35 RHO	CSS 150-200 / 35 RHO	150	0,20	35	35	15	13	13	7,5	200	500
CRS 150-250 / 35 RHO	CSS 150-250 / 35 RHO	150	0,20	35	35	15	13	13	7,5	250	500
CRS 150-300 / 35 RHO	CSS 150-300 / 35 RHO	150	0,20	35	35	15	13	13	7,5	300	500
CRS 150-350 / 35 RHO	CSS 150-350 / 35 RHO	150	0,20	35	35	15	13	13	7,5	350	500
CRS 150-400 / 35 RHO	CSS 150-400 / 35 RHO	150	0,20	35	35	15	13	13	7,5	400	500
CRS 150-500 / 35 RHO	CSS 150-500 / 35 RHO	150	0,20	35	35	15	13	13	7,5	500	500
CRS 150-600 / 35 RHO	CSS 150-600 / 35 RHO	150	0,20	35	35	15	13	13	7,5	600	500
CRS 200-250 / 40 RHO	CSS 200-250 / 40 RHO	200	0,20	40	40	20	13	13	8,3	250	550
CRS 200-300 / 40 RHO	CSS 200-300 / 40 RHO	200	0,20	40	40	20	13	13	8,3	300	550
CRS 200-350 / 40 RHO	CSS 200-350 / 40 RHO	200	0,20	40	40	20	13	13	8,3	350	550
CRS 200-400 / 40 RHO	CSS 200-400 / 40 RHO	200	0,20	40	40	20	13	13	8,3	400	550
CRS 200-500 / 40 RHO	CSS 200-500 / 40 RHO	200	0,20	40	40	20	13	13	8,3	500	550
CRS 200-600 / 40 RHO	CSS 200-600 / 40 RHO	200	0,20	40	40	20	13	13	8,3	600	550
CRS 250-250 / 40 RHO	CSS 250-250 / 40 RHO	250	0,20	40	40	20	13	13	10	250	630
CRS 250-300 / 40 RHO	CSS 250-300 / 40 RHO	250	0,20	40	40	20	13	13	10	300	630
CRS 250-350 / 40 RHO	CSS 250-350 / 40 RHO	250	0,20	40	40	20	13	13	10	350	630
CRS 250-400 / 40 RHO	CSS 250-400 / 40 RHO	250	0,20	40	40	20	13	13	10	400	630
CRS 250-500 / 40 RHO	CSS 250-500 / 40 RHO	250	0,20	40	40	20	13	13	10	500	630
CRS 250-600 / 40 RHO	CSS 250-600 / 40 RHO	250	0,20	40	40	20	13	13	10	600	630

Larghezze, lunghezze, sezioni e forature non comprese in tabella vengono allestite su richiesta.

\* Le intensità ammissibili sono a titolo indicativo, esse dipendono dalle condizioni di installazione e di esercizio. Non possono implicare in nessun caso la responsabilità del costruttore.

Widths, lengths, sections and bores are not included in table above, they are provided at request.

\* All information concerning ampacity is not binding, the values shown above are approximate values. The manufacturer shall not be held responsible under any circumstance.



# COLLEGAMENTI FLESSIBILI IN CORDA ROTONDA con attacco contenuto e isolamento siliconico RHO

## ROUND BRAIDED SHUNTS with reduced terminal and silicone insulation RHO

- ▶ Terminali in tubo di rame stagnato  
*Pressed copper connectors, tin coated*
- ▶ Filo elementare | *Single wire*  
Cu ETP UNI EN 1977-78:2000  
0,20 standard  
0,10 su richiesta | *on request*

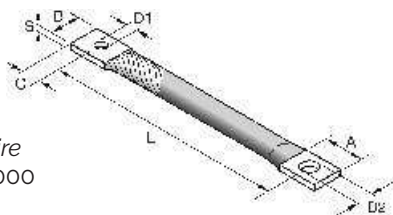

Rame Rosso <i>Red Copper</i>	Rame Stagnato <i>Tinned Copper</i>	Sezione mm <sup>2</sup> <i>Section</i>	Ø Filo <i>Wire dia.</i>	A mm.	B mm.	C mm.	D1 mm.	D2 mm.	S mm.	L mm.	Portata max AC Amps <i>Ampacity</i>
CCR 50-200 / 20 RHO	CCS 50-200 / 20 RHO	50	0,20	20	20	10	9	9	5,3	200	250
CCR 50-250 / 20 RHO	CCS 50-250 / 20 RHO	50	0,20	20	20	10	9	9	5,3	250	250
CCR 50-300 / 20 RHO	CCS 50-300 / 20 RHO	50	0,20	20	20	10	9	9	5,3	300	250
CCR 50-350 / 20 RHO	CCS 50-350 / 20 RHO	50	0,20	20	20	10	9	9	5,3	350	250
CCR 50-400 / 20 RHO	CCS 50-400 / 20 RHO	50	0,20	20	20	10	9	9	5,3	400	250
CCR 50-500 / 20 RHO	CCS 50-500 / 20 RHO	50	0,20	20	20	10	9	9	5,3	500	250
CCR 50-600 / 20 RHO	CCS 50-600 / 20 RHO	50	0,20	20	20	10	9	9	5,3	600	250
CCR 70-200 / 22 RHO	CCS 70-200 / 22 RHO	70	0,20	22	22	10	11	11	6,7	200	300
CCR 70-250 / 22 RHO	CCS 70-250 / 22 RHO	70	0,20	22	22	10	11	11	6,7	250	300
CCR 70-300 / 22 RHO	CCS 70-300 / 22 RHO	70	0,20	22	22	10	11	11	6,7	300	300
CCR 70-350 / 22 RHO	CCS 70-350 / 22 RHO	70	0,20	22	22	10	11	11	6,7	350	300
CCR 70-400 / 22 RHO	CCS 70-400 / 22 RHO	70	0,20	22	22	10	11	11	6,7	400	300
CCR 70-500 / 22 RHO	CCS 70-500 / 22 RHO	70	0,20	22	22	10	11	11	6,7	500	300
CCR 70-600 / 22 RHO	CCS 70-600 / 22 RHO	70	0,20	22	22	10	11	11	6,7	600	300
CCR 100-200 / 25 RHO	CCS 100-200 / 25 RHO	100	0,20	25	25	12	11	11	7,3	200	350
CCR 100-250 / 25 RHO	CCS 100-250 / 25 RHO	100	0,20	25	25	12	11	11	7,3	250	350
CCR 100-300 / 25 RHO	CCS 100-300 / 25 RHO	100	0,20	25	25	12	11	11	7,3	300	350
CCR 100-350 / 25 RHO	CCS 100-350 / 25 RHO	100	0,20	25	25	12	11	11	7,3	350	350
CCR 100-400 / 25 RHO	CCS 100-400 / 25 RHO	100	0,20	25	25	12	11	11	7,3	400	350
CCR 100-500 / 25 RHO	CCS 100-500 / 25 RHO	100	0,20	25	25	12	11	11	7,3	500	350
CCR 100-600 / 25 RHO	CCS 100-600 / 25 RHO	100	0,20	25	25	12	11	11	7,3	600	350
CCR 120-200 / 25 RHO	CCS 120-200 / 25 RHO	120	0,20	25	25	12	11	11	8,3	200	400
CCR 120-250 / 25 RHO	CCS 120-250 / 25 RHO	120	0,20	25	25	12	11	11	8,3	250	400
CCR 120-300 / 25 RHO	CCS 120-300 / 25 RHO	120	0,20	25	25	12	11	11	8,3	300	400
CCR 120-350 / 25 RHO	CCS 120-350 / 25 RHO	120	0,20	25	25	12	11	11	8,3	350	400
CCR 120-400 / 25 RHO	CCS 120-400 / 25 RHO	120	0,20	25	25	12	11	11	8,3	400	400
CCR 120-500 / 25 RHO	CCS 120-500 / 25 RHO	120	0,20	25	25	12	11	11	8,3	500	400
CCR 120-600 / 25 RHO	CCS 120-600 / 25 RHO	120	0,20	25	25	12	11	11	8,3	600	400
CCR 150-200 / 30 RHO	CCS 150-200 / 30 RHO	150	0,20	30	30	15	13	13	8,5	200	500
CCR 150-250 / 30 RHO	CCS 150-250 / 30 RHO	150	0,20	30	30	15	13	13	8,5	250	500
CCR 150-300 / 30 RHO	CCS 150-300 / 30 RHO	150	0,20	30	30	15	13	13	8,5	300	500
CCR 150-350 / 30 RHO	CCS 150-350 / 30 RHO	150	0,20	30	30	15	13	13	8,5	350	500
CCR 150-400 / 30 RHO	CCS 150-400 / 30 RHO	150	0,20	30	30	15	13	13	8,5	400	500
CCR 150-500 / 30 RHO	CCS 150-500 / 30 RHO	150	0,20	30	30	15	13	13	8,5	500	500
CCR 150-600 / 30 RHO	CCS 150-600 / 30 RHO	150	0,20	30	30	15	13	13	8,5	600	500
CCR 200-250 / 35 RHO	CCS 200-250 / 35 RHO	200	0,20	35	35	15	13	13	9,3	250	550
CCR 200-300 / 35 RHO	CCS 200-250 / 35 RHO	200	0,20	35	35	15	13	13	9,3	300	550
CCR 200-350 / 35 RHO	CCS 200-250 / 35 RHO	200	0,20	35	35	15	13	13	9,3	350	550
CCR 200-400 / 35 RHO	CCS 200-250 / 35 RHO	200	0,20	35	35	15	13	13	9,3	400	550
CCR 200-500 / 35 RHO	CCS 200-250 / 35 RHO	200	0,20	35	35	15	13	13	9,3	500	550
CCR 200-600 / 35 RHO	CCS 200-250 / 35 RHO	200	0,20	35	35	15	13	13	9,3	600	550
CCR 240-250 / 40 RHO	CCS 240-250 / 40 RHO	240	0,20	40	40	20	13	13	10,0	250	630
CCR 240-300 / 40 RHO	CCS 240-300 / 40 RHO	240	0,20	40	40	20	13	13	10,0	300	630
CCR 240-350 / 40 RHO	CCS 240-350 / 40 RHO	240	0,20	40	40	20	13	13	10,0	350	630
CCR 240-400 / 40 RHO	CCS 240-400 / 40 RHO	240	0,20	40	40	20	13	13	10,0	400	630
CCR 240-500 / 40 RHO	CCS 240-500 / 40 RHO	240	0,20	40	40	20	13	13	10,0	500	630
CCR 240-600 / 40 RHO	CCS 240-600 / 40 RHO	240	0,20	40	40	20	13	13	10,0	600	630
CCR 300-250 / 40 RHO	CCS 300-250 / 40 RHO	300	0,20	40	40	20	13	13	11,5	250	700
CCR 300-300 / 40 RHO	CCS 300-300 / 40 RHO	300	0,20	40	40	20	13	13	11,5	300	700
CCR 300-350 / 40 RHO	CCS 300-350 / 40 RHO	300	0,20	40	40	20	13	13	11,5	350	700
CCR 300-400 / 40 RHO	CCS 300-400 / 40 RHO	300	0,20	40	40	20	13	13	11,5	400	700
CCR 300-500 / 40 RHO	CCS 300-500 / 40 RHO	300	0,20	40	40	20	13	13	11,5	500	700
CCR 300-600 / 40 RHO	CCS 300-600 / 40 RHO	300	0,20	40	40	20	13	13	11,5	600	700

Larghezze, lunghezze, sezioni e forature non comprese in tabella vengono allestite su richiesta.

\* Le intensità ammissibili sono a titolo indicativo, esse dipendono dalle condizioni di installazione e di esercizio. Non possono implicare in nessun caso la responsabilità del costruttore.

Widths, lengths, sections and bores are not included in table above, they are provided at request.

\* All information concerning ampacity is not binding, the values shown above are approximate values. The manufacturer shall not be held responsible under any circumstance.

# COLLEGAMENTI FLESSIBILI IN TRECCIA PIATTA con isolamento siliconico SYL

## FLAT BRAIDED SHUNTS with silicone insulation SYL

► Terminali in tubo di rame stagnato  
stagnato  
*Pressed copper  
connectors, tin coated*

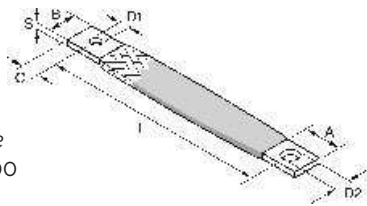

► Filo elementare | *Single wire*  
Cu ETP UNI EN 1977-78:2000  
0,20 standard  
0,10 su richiesta | *on request*



**AI**  
E353125

Rame Rosso <i>Red Copper</i>	Rame Stagnato <i>Tinned Copper</i>	Sezione mm <sup>2</sup> <i>Section</i>	Ø Filo <i>Wire dia.</i>	A mm.	B mm.	C mm.	D1 mm.	D2 mm.	S mm.	L mm.	Portata max AC Amps <i>Ampacity</i>
CRS 25-150 / 20 SYL	CSS 25-150 / 20 SYL	25	0,20	20	20	10	9	9	3,2	150	160
CRS 25-200 / 20 SYL	CSS 25-200 / 20 SYL	25	0,20	20	20	10	9	9	3,2	200	160
CRS 25-250 / 20 SYL	CSS 25-250 / 20 SYL	25	0,20	20	20	10	9	9	3,2	250	160
CRS 25-300 / 20 SYL	CSS 25-300 / 20 SYL	25	0,20	20	20	10	9	9	3,2	300	160
CRS 25-400 / 20 SYL	CSS 25-400 / 20 SYL	25	0,20	20	20	10	9	9	3,2	400	160
CRS 25-500 / 20 SYL	CSS 25-500 / 20 SYL	25	0,20	20	20	10	9	9	3,2	500	160
CRS 25-600 / 20 SYL	CSS 25-600 / 20 SYL	25	0,20	20	20	10	9	9	3,2	600	160
CRS 35-150 / 20 SYL	CSS 35-150 / 20 SYL	35	0,20	20	20	10	9	9	3,4	150	200
CRS 35-200 / 20 SYL	CSS 35-200 / 20 SYL	35	0,20	20	20	10	9	9	3,4	200	200
CRS 35-250 / 20 SYL	CSS 35-250 / 20 SYL	35	0,20	20	20	10	9	9	3,4	250	200
CRS 35-300 / 20 SYL	CSS 35-300 / 20 SYL	35	0,20	20	20	10	9	9	3,4	300	200
CRS 35-400 / 20 SYL	CSS 35-400 / 20 SYL	35	0,20	20	20	10	9	9	3,4	400	200
CRS 35-500 / 20 SYL	CSS 35-500 / 20 SYL	35	0,20	20	20	10	9	9	3,4	500	200
CRS 35-600 / 20 SYL	CSS 35-600 / 20 SYL	35	0,20	20	20	10	9	9	3,4	600	200
CRS 50-150 / 25 SYL	CSS 50-150 / 25 SYL	50	0,20	25	25	12,5	11	11	4,5	150	250
CRS 50-200 / 25 SYL	CSS 50-200 / 25 SYL	50	0,20	25	25	12,5	11	11	4,5	200	250
CRS 50-250 / 25 SYL	CSS 50-250 / 25 SYL	50	0,20	25	25	12,5	11	11	4,5	250	250
CRS 50-300 / 25 SYL	CSS 50-300 / 25 SYL	50	0,20	25	25	12,5	11	11	4,5	300	250
CRS 50-400 / 25 SYL	CSS 50-400 / 25 SYL	50	0,20	25	25	12,5	11	11	4,5	400	250
CRS 50-500 / 25 SYL	CSS 50-500 / 25 SYL	50	0,20	25	25	12,5	11	11	4,5	500	250
CRS 50-600 / 25 SYL	CSS 50-600 / 25 SYL	50	0,20	25	25	12,5	11	11	4,5	600	250
CRS 75-150 / 30 SYL	CSS 75-150 / 30 SYL	75	0,20	30	30	15	11	11	5,0	150	300
CRS 75-200 / 30 SYL	CSS 75-200 / 30 SYL	75	0,20	30	30	15	11	11	5,0	200	300
CRS 75-250 / 30 SYL	CSS 75-250 / 30 SYL	75	0,20	30	30	15	11	11	5,0	250	300
CRS 75-300 / 30 SYL	CSS 75-300 / 30 SYL	75	0,20	30	30	15	11	11	5,0	300	300
CRS 75-400 / 30 SYL	CSS 75-400 / 30 SYL	75	0,20	30	30	15	11	11	5,0	400	300
CRS 75-500 / 30 SYL	CSS 75-500 / 30 SYL	75	0,20	30	30	15	11	11	5,0	500	300
CRS 75-600 / 30 SYL	CSS 75-600 / 30 SYL	75	0,20	30	30	15	11	11	5,0	600	300
CRS 100-200 / 35 SYL	CSS 100-200 / 35 SYL	100	0,20	35	35	15	11	11	5,6	200	350
CRS 100-250 / 35 SYL	CSS 100-250 / 35 SYL	100	0,20	35	35	15	11	11	5,6	250	350
CRS 100-300 / 35 SYL	CSS 100-300 / 35 SYL	100	0,20	35	35	15	11	11	5,6	300	350
CRS 100-350 / 35 SYL	CSS 100-350 / 35 SYL	100	0,20	35	35	15	11	11	5,6	350	350
CRS 100-400 / 35 SYL	CSS 100-400 / 35 SYL	100	0,20	35	35	15	11	11	5,6	400	350
CRS 100-500 / 35 SYL	CSS 100-500 / 35 SYL	100	0,20	35	35	15	11	11	5,6	500	350
CRS 100-600 / 35 SYL	CSS 100-600 / 35 SYL	100	0,20	35	35	15	11	11	5,6	600	350
CRS 120-200 / 35 SYL	CSS 120-200 / 35 SYL	120	0,20	35	35	15	11	11	6,5	200	400
CRS 120-250 / 35 SYL	CSS 120-250 / 35 SYL	120	0,20	35	35	15	11	11	6,5	250	400
CRS 120-300 / 35 SYL	CSS 120-300 / 35 SYL	120	0,20	35	35	15	11	11	6,5	300	400
CRS 120-350 / 35 SYL	CSS 120-350 / 35 SYL	120	0,20	35	35	15	11	11	6,5	350	400
CRS 120-400 / 35 SYL	CSS 120-400 / 35 SYL	120	0,20	35	35	15	11	11	6,5	400	400
CRS 120-500 / 35 SYL	CSS 120-500 / 35 SYL	120	0,20	35	35	15	11	11	6,5	500	400
CRS 120-600 / 35 SYL	CSS 120-600 / 35 SYL	120	0,20	35	35	15	11	11	6,5	600	400
CRS 150-200 / 35 SYL	CSS 150-200 / 35 SYL	150	0,20	35	35	15	13	13	7,5	200	500
CRS 150-250 / 35 SYL	CSS 150-250 / 35 SYL	150	0,20	35	35	15	13	13	7,5	250	500
CRS 150-300 / 35 SYL	CSS 150-300 / 35 SYL	150	0,20	35	35	15	13	13	7,5	300	500
CRS 150-350 / 35 SYL	CSS 150-350 / 35 SYL	150	0,20	35	35	15	13	13	7,5	350	500
CRS 150-400 / 35 SYL	CSS 150-400 / 35 SYL	150	0,20	35	35	15	13	13	7,5	400	500
CRS 150-500 / 35 SYL	CSS 150-500 / 35 SYL	150	0,20	35	35	15	13	13	7,5	500	500
CRS 150-600 / 35 SYL	CSS 150-600 / 35 SYL	150	0,20	35	35	15	13	13	7,5	600	500
CRS 200-250 / 40 SYL	CSS 200-250 / 40 SYL	200	0,20	40	40	20	13	13	8,3	250	550
CRS 200-300 / 40 SYL	CSS 200-300 / 40 SYL	200	0,20	40	40	20	13	13	8,3	300	550
CRS 200-350 / 40 SYL	CSS 200-350 / 40 SYL	200	0,20	40	40	20	13	13	8,3	350	550
CRS 200-400 / 40 SYL	CSS 200-400 / 40 SYL	200	0,20	40	40	20	13	13	8,3	400	550
CRS 200-500 / 40 SYL	CSS 200-500 / 40 SYL	200	0,20	40	40	20	13	13	8,3	500	550
CRS 200-600 / 40 SYL	CSS 200-600 / 40 SYL	200	0,20	40	40	20	13	13	8,3	600	550
CRS 250-250 / 40 SYL	CSS 250-250 / 40 SYL	250	0,20	40	40	20	13	13	10	250	630
CRS 250-300 / 40 SYL	CSS 250-300 / 40 SYL	250	0,20	40	40	20	13	13	10	300	630
CRS 250-350 / 40 SYL	CSS 250-350 / 40 SYL	250	0,20	40	40	20	13	13	10	350	630
CRS 250-400 / 40 SYL	CSS 250-400 / 40 SYL	250	0,20	40	40	20	13	13	10	400	630
CRS 250-500 / 40 SYL	CSS 250-500 / 40 SYL	250	0,20	40	40	20	13	13	10	500	630
CRS 250-600 / 40 SYL	CSS 250-600 / 40 SYL	250	0,20	40	40	20	13	13	10	600	630

Larghezze, lunghezze, sezioni e forature non comprese in tabella vengono allestite su richiesta.

\* Le intensità ammissibili sono a titolo indicativo, esse dipendono dalle condizioni di installazione e di esercizio. Non possono implicare in nessun caso la responsabilità del costruttore.

Widths, lengths, sections and bores are not included in table above, they are provided at request.

\* All information concerning ampacity is not binding, the values shown above are approximate values. The manufacturer shall not be held responsible under any circumstance.

# COLLEGAMENTI FLESSIBILI IN CORDA ROTONDA con attacco contenuto e isolamento siliconico SYL

## ROUND BRAIDED SHUNTS with reduced terminal and silicone insulation SYL

- ▶ Terminali in tubo di rame stagnato  
*Pressed copper connectors, tin coated*
- ▶ Filo elementare | *Single wire*  
Cu ETP UNI EN 1977-78:2000  
0,20 standard  
0,10 su richiesta | *on request*

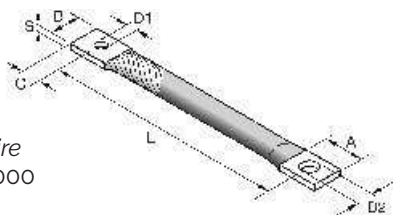

**AI**  
E353125

Rame Rosso <i>Red Copper</i>	Rame Stagnato <i>Tinned Copper</i>	Sezione mm <sup>2</sup> <i>Section</i>	Ø Filo <i>Wire dia.</i>	A mm.	B mm.	C mm.	D1 mm.	D2 mm.	S mm.	L mm.	Portata max AC Amps <i>Ampacity</i>
CCR 50-200 / 20 SYL	CCS 50-200 / 20 SYL	50	0,20	20	20	10	9	9	5,3	200	250
CCR 50-250 / 20 SYL	CCS 50-250 / 20 SYL	50	0,20	20	20	10	9	9	5,3	250	250
CCR 50-300 / 20 SYL	CCS 50-300 / 20 SYL	50	0,20	20	20	10	9	9	5,3	300	250
CCR 50-350 / 20 SYL	CCS 50-350 / 20 SYL	50	0,20	20	20	10	9	9	5,3	350	250
CCR 50-400 / 20 SYL	CCS 50-400 / 20 SYL	50	0,20	20	20	10	9	9	5,3	400	250
CCR 50-500 / 20 SYL	CCS 50-500 / 20 SYL	50	0,20	20	20	10	9	9	5,3	500	250
CCR 50-600 / 20 SYL	CCS 50-600 / 20 SYL	50	0,20	20	20	10	9	9	5,3	600	250
CCR 70-200 / 22 SYL	CCS 70-200 / 22 SYL	70	0,20	22	22	10	11	11	6,7	200	300
CCR 70-250 / 22 SYL	CCS 70-250 / 22 SYL	70	0,20	22	22	10	11	11	6,7	250	300
CCR 70-300 / 22 SYL	CCS 70-300 / 22 SYL	70	0,20	22	22	10	11	11	6,7	300	300
CCR 70-350 / 22 SYL	CCS 70-350 / 22 SYL	70	0,20	22	22	10	11	11	6,7	350	300
CCR 70-400 / 22 SYL	CCS 70-400 / 22 SYL	70	0,20	22	22	10	11	11	6,7	400	300
CCR 70-500 / 22 SYL	CCS 70-500 / 22 SYL	70	0,20	22	22	10	11	11	6,7	500	300
CCR 70-600 / 22 SYL	CCS 70-600 / 22 SYL	70	0,20	22	22	10	11	11	6,7	600	300
CCR 100-200 / 25 SYL	CCS 100-200 / 25 SYL	100	0,20	25	25	12	11	11	7,3	200	350
CCR 100-250 / 25 SYL	CCS 100-250 / 25 SYL	100	0,20	25	25	12	11	11	7,3	250	350
CCR 100-300 / 25 SYL	CCS 100-300 / 25 SYL	100	0,20	25	25	12	11	11	7,3	300	350
CCR 100-350 / 25 SYL	CCS 100-350 / 25 SYL	100	0,20	25	25	12	11	11	7,3	350	350
CCR 100-400 / 25 SYL	CCS 100-400 / 25 SYL	100	0,20	25	25	12	11	11	7,3	400	350
CCR 100-500 / 25 SYL	CCS 100-500 / 25 SYL	100	0,20	25	25	12	11	11	7,3	500	350
CCR 100-600 / 25 SYL	CCS 100-600 / 25 SYL	100	0,20	25	25	12	11	11	7,3	600	350
CCR 120-200 / 25 SYL	CCS 120-200 / 25 SYL	120	0,20	25	25	12	11	11	8,3	200	400
CCR 120-250 / 25 SYL	CCS 120-250 / 25 SYL	120	0,20	25	25	12	11	11	8,3	250	400
CCR 120-300 / 25 SYL	CCS 120-300 / 25 SYL	120	0,20	25	25	12	11	11	8,3	300	400
CCR 120-350 / 25 SYL	CCS 120-350 / 25 SYL	120	0,20	25	25	12	11	11	8,3	350	400
CCR 120-400 / 25 SYL	CCS 120-400 / 25 SYL	120	0,20	25	25	12	11	11	8,3	400	400
CCR 120-500 / 25 SYL	CCS 120-500 / 25 SYL	120	0,20	25	25	12	11	11	8,3	500	400
CCR 120-600 / 25 SYL	CCS 120-600 / 25 SYL	120	0,20	25	25	12	11	11	8,3	600	400
CCR 150-200 / 30 SYL	CCS 150-200 / 30 SYL	150	0,20	30	30	15	13	13	8,5	200	500
CCR 150-250 / 30 SYL	CCS 150-250 / 30 SYL	150	0,20	30	30	15	13	13	8,5	250	500
CCR 150-300 / 30 SYL	CCS 150-300 / 30 SYL	150	0,20	30	30	15	13	13	8,5	300	500
CCR 150-350 / 30 SYL	CCS 150-350 / 30 SYL	150	0,20	30	30	15	13	13	8,5	350	500
CCR 150-400 / 30 SYL	CCS 150-400 / 30 SYL	150	0,20	30	30	15	13	13	8,5	400	500
CCR 150-500 / 30 SYL	CCS 150-500 / 30 SYL	150	0,20	30	30	15	13	13	8,5	500	500
CCR 150-600 / 30 SYL	CCS 150-600 / 30 SYL	150	0,20	30	30	15	13	13	8,5	600	500
CCR 200-250 / 35 SYL	CCS 200-250 / 35 SYL	200	0,20	35	35	15	13	13	9,3	250	550
CCR 200-300 / 35 SYL	CCS 200-250 / 35 SYL	200	0,20	35	35	15	13	13	9,3	300	550
CCR 200-350 / 35 SYL	CCS 200-250 / 35 SYL	200	0,20	35	35	15	13	13	9,3	350	550
CCR 200-400 / 35 SYL	CCS 200-250 / 35 SYL	200	0,20	35	35	15	13	13	9,3	400	550
CCR 200-500 / 35 SYL	CCS 200-250 / 35 SYL	200	0,20	35	35	15	13	13	9,3	500	550
CCR 200-600 / 35 SYL	CCS 200-250 / 35 SYL	200	0,20	35	35	15	13	13	9,3	600	550
CCR 240-250 / 40 SYL	CCS 240-250 / 40 SYL	240	0,20	40	40	20	13	13	10,0	250	630
CCR 240-300 / 40 SYL	CCS 240-300 / 40 SYL	240	0,20	40	40	20	13	13	10,0	300	630
CCR 240-350 / 40 SYL	CCS 240-350 / 40 SYL	240	0,20	40	40	20	13	13	10,0	350	630
CCR 240-400 / 40 SYL	CCS 240-400 / 40 SYL	240	0,20	40	40	20	13	13	10,0	400	630
CCR 240-500 / 40 SYL	CCS 240-500 / 40 SYL	240	0,20	40	40	20	13	13	10,0	500	630
CCR 240-600 / 40 SYL	CCS 240-600 / 40 SYL	240	0,20	40	40	20	13	13	10,0	600	630
CCR 300-250 / 40 SYL	CCS 300-250 / 40 SYL	300	0,20	40	40	20	13	13	11,5	250	700
CCR 300-300 / 40 SYL	CCS 300-300 / 40 SYL	300	0,20	40	40	20	13	13	11,5	300	700
CCR 300-350 / 40 SYL	CCS 300-350 / 40 SYL	300	0,20	40	40	20	13	13	11,5	350	700
CCR 300-400 / 40 SYL	CCS 300-400 / 40 SYL	300	0,20	40	40	20	13	13	11,5	400	700
CCR 300-500 / 40 SYL	CCS 300-500 / 40 SYL	300	0,20	40	40	20	13	13	11,5	500	700
CCR 300-600 / 40 SYL	CCS 300-600 / 40 SYL	300	0,20	40	40	20	13	13	11,5	600	700

Larghezze, lunghezze, sezioni e forature non comprese in tabella vengono allestite su richiesta.

\* Le intensità ammissibili sono a titolo indicativo, esse dipendono dalle condizioni di installazione e di esercizio. Non possono implicare in nessun caso la responsabilità del costruttore.

Widths, lengths, sections and bores are not included in table above, they are provided at request.

\* All information concerning ampacity is not binding, the values shown above are approximate values. The manufacturer shall not be held responsible under any circumstance.

# COLLEGAMENTI FLESSIBILI IN TRECCIA PIATTA con isolamento vinilico HT105 UL94V0

## FLAT BRAIDED SHUNTS with HT105 insulation UL94V0

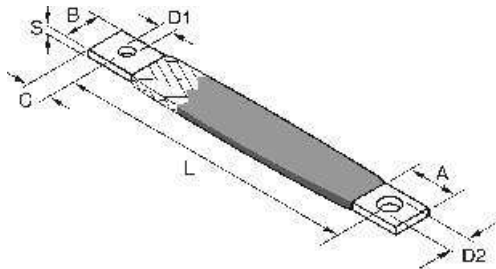

### Caratteristiche tecniche

Tensione max esercizio: 1000 V CA - 1500 V DC  
 Intensità: da 160 a 630 A  
 Treccia di rame rosso o stagnato con filo elementare 0,20mm Cu ETP UNI EN 1977-78:2000  
 Terminali di rame stagnato  
 Messa in parallelo dei collegamenti:

numero di connessioni	coefficiente
2	1,7
3	2,3
4	3,0

### Characteristic

Operating voltage: 1000 V CA - 1500 V DC  
 Rated current: 160 to 630 Amps  
 Copper braid bare or tinned copper single wire 0,20 Cu ETP UNI EN 1977-78:2000  
 Pressed copper connectors , tin coated  
 Parallel connections:

number of connections	factor
2	1,7
3	2,3
4	3,0

### Caratteristiche dell'isolante - spessore 2mm

Autoestingente	UL94V0	HT105°C	
Temperatura d'esercizio	max 105	°C	
Durezza	82 ± 2	Shore A	ISO 868
Carico di rottura	14,5 ± 3	N/mm <sup>2</sup>	CEI 20-34/1-1
Temperatura irrigimento a torsione	-34,5 ± 4	°C	ISO 458
Allungamento a rottura	275 ± 30	%	CEI 20-34/1-1
Rigidità dielettrica	300 ± 50	KV/cm	DIN 53481

### Insulation characteristics - 2mm thick

Self-extinguishing	UL94V0	HT105°C	
Operating temperature	max 105	°C	
Hardness	82 ± 2	Shore A	ISO 868
Tensile strength	14,5 ± 3	N/mm <sup>2</sup>	CEI 20-34/1-1
Twist cold shortness temp	-34,5 ± 4	°C	ISO 458
Elongation at break	275 ± 30	%	CEI 20-34/1-1
Dielectric strength	300 ± 50	KV/cm	DIN 53481

Rame Rosso <i>Red Copper</i>	Rame Stagnato <i>Tinned Copper</i>	Sezione mm <sup>2</sup> <i>Section</i>	Ø Filo Wire dia.	A mm.	B mm.	C mm.	D1 mm.	D2 mm.	S mm.	L mm.	Portata max AC Amps <i>Ampacity</i>
CR/S 25-150 / 23 HT105	CS 25-150 / 23 HT105	25	0,20	23	23	10	9	11	3,2	150	160
CR/S 25-200 / 23 HT105	CS 25-200 / 23 HT105	25	0,20	23	23	10	9	11	3,2	200	160
CR/S 25-250 / 23 HT105	CS 25-250 / 23 HT105	25	0,20	23	23	10	9	11	3,2	250	160
CR/S 25-300 / 23 HT105	CS 25-300 / 23 HT105	25	0,20	23	23	10	9	11	3,2	300	160
CR/S 25-400 / 23 HT105	CS 25-400 / 23 HT105	25	0,20	23	23	10	9	11	3,2	400	160
CR/S 25-500 / 23 HT105	CS 25-500 / 23 HT105	25	0,20	23	23	10	9	11	3,2	500	160
CR/S 25-600 / 23 HT105	CS 25-600 / 23 HT105	25	0,20	23	23	10	9	11	3,2	600	160
CR/S 35-150 / 23 HT105	CS 35-150 / 23 HT105	35	0,20	23	23	10	9	11	3,4	150	200
CR/S 35-200 / 23 HT105	CS 35-200 / 23 HT105	35	0,20	23	23	10	9	11	3,4	200	200
CR/S 35-250 / 23 HT105	CS 35-250 / 23 HT105	35	0,20	23	23	10	9	11	3,4	250	200
CR/S 35-300 / 23 HT105	CS 35-300 / 23 HT105	35	0,20	23	23	10	9	11	3,4	300	200
CR/S 35-400 / 23 HT105	CS 35-400 / 23 HT105	35	0,20	23	23	10	9	11	3,4	400	200
CR/S 35-500 / 23 HT105	CS 35-500 / 23 HT105	35	0,20	23	23	10	9	11	3,4	500	200
CR/S 35-600 / 23 HT105	CS 35-600 / 23 HT105	35	0,20	23	23	10	9	11	3,4	600	200
CR/S 50-150 / 20 HT105	CS 50-150 / 20 HT105	50	0,20	20	20	10	11	11	5,0	150	250
CR/S 50-200 / 20 HT105	CS 50-200 / 20 HT105	50	0,20	20	20	10	11	11	5,0	200	250
CR/S 50-250 / 20 HT105	CS 50-250 / 20 HT105	50	0,20	20	20	10	11	11	5,0	250	250
CR/S 50-300 / 20 HT105	CS 50-300 / 20 HT105	50	0,20	20	20	10	11	11	5,0	300	250
CR/S 50-400 / 20 HT105	CS 50-400 / 20 HT105	50	0,20	20	20	10	11	11	5,0	400	250
CR/S 50-500 / 20 HT105	CS 50-500 / 20 HT105	50	0,20	20	20	10	11	11	5,0	500	250
CR/S 50-600 / 20 HT105	CS 50-600 / 20 HT105	50	0,20	20	20	10	11	11	5,0	600	250
CR/S 50-150 / 30 HT105	CS 50-150 / 30 HT105	50	0,20	30	30	15	11	13	4,5	150	250
CR/S 50-200 / 30 HT105	CS 50-200 / 30 HT105	50	0,20	30	30	15	11	13	4,5	200	250
CR/S 50-250 / 30 HT105	CS 50-250 / 30 HT105	50	0,20	30	30	15	11	13	4,5	250	250
CR/S 50-300 / 30 HT105	CS 50-300 / 30 HT105	50	0,20	30	30	15	11	13	4,5	300	250
CR/S 50-400 / 30 HT105	CS 50-400 / 30 HT105	50	0,20	30	30	15	11	13	4,5	400	250
CR/S 50-500 / 30 HT105	CS 50-500 / 30 HT105	50	0,20	30	30	15	11	13	4,5	500	250
CR/S 50-600 / 30 HT105	CS 50-600 / 30 HT105	50	0,20	30	30	15	11	13	4,5	600	250
CR/S 100-250 / 25 HT105	CS/S 100-250 / 25 HT105	100	0,20	25	25	12	11	11	7,0	250	350
CR/S 100-300 / 25 HT105	CS/S 100-300 / 25 HT105	100	0,20	25	25	12	11	11	7,0	300	350
CR/S 100-400 / 25 HT105	CS/S 100-400 / 25 HT105	100	0,20	25	25	12	11	11	7,0	400	350
CR/S 100-500 / 25 HT105	CS/S 100-500 / 25 HT105	100	0,20	25	25	12	11	11	7,0	500	350
CR/S 100-600 / 25 HT105	CS/S 100-600 / 25 HT105	100	0,20	25	25	12	11	11	7,0	600	350
CR/S 100-800 / 25 HT105	CS/S 100-800 / 25 HT105	100	0,20	25	25	12	11	11	7,0	800	350
CR/S 100-250 / 30 HT105	CS/S 100-250 / 30 HT105	100	0,20	30	30	15	11	13	6,3	250	350
CR/S 100-300 / 30 HT105	CS/S 100-300 / 30 HT105	100	0,20	30	30	15	11	13	6,3	300	350
CR/S 100-400 / 30 HT105	CS/S 100-400 / 30 HT105	100	0,20	30	30	15	11	13	6,3	400	350
CR/S 100-500 / 30 HT105	CS/S 100-500 / 30 HT105	100	0,20	30	30	15	11	13	6,3	500	350
CR/S 100-600 / 30 HT105	CS/S 100-600 / 30 HT105	100	0,20	30	30	15	11	13	6,3	600	350
CR/S 100-800 / 30 HT105	CS/S 100-800 / 30 HT105	100	0,20	30	30	15	11	13	6,3	800	350
CR/S 120-250 / 30 HT105	CS/S 120-250 / 30 HT105	120	0,20	30	30	15	11	11	7,2	250	400
CR/S 120-300 / 30 HT105	CS/S 120-300 / 30 HT105	120	0,20	30	30	15	11	11	7,2	300	400
CR/S 120-400 / 30 HT105	CS/S 120-400 / 30 HT105	120	0,20	30	30	15	11	11	7,2	400	400
CR/S 120-500 / 30 HT105	CS/S 120-500 / 30 HT105	120	0,20	30	30	15	11	11	7,2	500	400
CR/S 120-600 / 30 HT105	CS/S 120-600 / 30 HT105	120	0,20	30	30	15	11	11	7,2	600	400
CR/S 120-800 / 30 HT105	CS/S 120-800 / 30 HT105	120	0,20	30	30	15	11	11	7,2	800	400
CR/S 240-300 / 40 HT105	CS/S 240-300 / 40 HT105	240	0,20	40	40	20	13	13	10	300	630
CR/S 240-400 / 40 HT105	CS/S 240-400 / 40 HT105	240	0,20	40	40	20	13	13	10	400	630
CR/S 240-500 / 40 HT105	CS/S 240-500 / 40 HT105	240	0,20	40	40	20	13	13	10	500	630
CR/S 240-600 / 40 HT105	CS/S 240-600 / 40 HT105	240	0,20	40	40	20	13	13	10	600	630
CR/S 240-800 / 40 HT105	CS/S 240-800 / 40 HT105	240	0,20	40	40	20	13	13	10	800	630

Larghezze, lunghezze, sezioni e forature non comprese in tabella vengono allestite su richiesta.

\* Le intensità ammissibili sono a titolo indicativo, esse dipendono dalle condizioni di installazione e di esercizio. Non possono implicare in nessun caso la responsabilità del costruttore.

Widths, lengths, sections and bores are not included in table above, they are provided at request.

\* All information concerning ampacity is not binding, the values shown above are approximate values. The manufacturer shall not be held responsible under any circumstance.

# TRECCE DI MASSA EARTHING STRAPS

- ▶ Terminali in lamiera di rame  
*Copper strip terminals*
- ▶ Filo elementare Cu ETP UNI 1977-78:2000  
*Single wire Cu ETP UNI 1977-78:2000. Similar to DIN 72333*

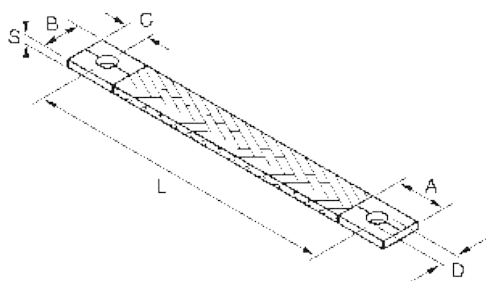

Rame Rosso <i>Red Copper</i>	Rame Stagnato <i>Tinned Copper</i>	Sezione mm <sup>2</sup> <i>Section</i>	Ø Filo Wire dia.	A mm.	B mm.	C mm.	D mm.	S mm.	L mm.
CR 6 - 75/010/07	CS 6 - 75/010/07	6	0,10	13	11	5	7	2,0	75
* CR 6 - 100/010/07	* CS 6 - 100/010/07	6	0,10	13	11	5	7	2,0	100
* CR 6 - 150/010/07	* CS 6 - 150/010/07	6	0,10	13	11	5	7	2,0	150
CR 6 - 200/010/07	CS 6 - 200/010/07	6	0,10	13	11	5	7	2,0	200
* CR 10 - 100/020/09	CS 10 - 100/020/09	10	0,20	23	17	10	9	2,0	100
* CR 10 - 150/020/09	* CS 10 - 150/020/09	10	0,20	23	17	10	9	2,0	150
* CR 10 - 200/020/09	* CS 10 - 200/020/09	10	0,20	23	17	10	9	2,0	200
* CR 10 - 250/020/09	* CS 10 - 250/020/09	10	0,20	23	17	10	9	2,0	250
CR 10 - 300/020/09	* CS 10 - 300/020/09	10	0,20	23	17	10	9	2,0	300
* CR 16 - 100/020/09	* CS 16 - 100/020/09	16	0,20	23	17	10	9	2,5	100
* CR 16 - 150/020/09	* CS 16 - 150/020/09	16	0,20	23	17	10	9	2,5	150
* CR 16 - 200/020/09	* CS 16 - 200/020/09	16	0,20	23	17	10	9	2,5	200
* CR 16 - 250/020/09	* CS 16 - 250/020/09	16	0,20	23	17	10	9	2,5	250
* CR 16 - 300/020/09	* CS 16 - 300/020/09	16	0,20	23	17	10	9	2,5	300
* CR 16 - 350/020/09	* CS 16 - 350/020/09	16	0,20	23	17	10	9	2,5	350
* CR 16 - 400/020/09	* CS 16 - 400/020/09	16	0,20	23	17	10	9	2,5	400
CR 25 - 100/020/09	CS 25 - 100/020/09	25	0,20	23	23	10	9	3,2	100
* CR 25 - 150/020/09	* CS 25 - 150/020/09	25	0,20	23	23	10	9	3,2	150
* CR 25 - 200/020/09	* CS 25 - 200/020/09	25	0,20	23	23	10	9	3,2	200
* CR 25 - 250/020/09	* CS 25 - 250/020/09	25	0,20	23	23	10	9	3,2	250
* CR 25 - 300/020/09	* CS 25 - 300/020/09	25	0,20	23	23	10	9	3,2	300
CR 25 - 400/020/09	CS 25 - 400/020/09	25	0,20	23	23	10	9	3,2	400
CR 35 - 100/020/09	CS 35 - 100/020/09	35	0,20	23	23	10	9	3,4	100
* CR 35 - 150/020/09	* CS 35 - 150/020/09	35	0,20	23	23	10	9	3,4	150
* CR 35 - 200/020/09	* CS 35 - 200/020/09	35	0,20	23	23	10	9	3,4	200
* CR 35 - 250/020/09	* CS 35 - 250/020/09	35	0,20	23	23	10	9	3,4	250
* CR 35 - 300/020/09	* CS 35 - 300/020/09	35	0,20	23	23	10	9	3,4	300
CR 35 - 400/020/09	CS 35 - 400/020/09	35	0,20	23	23	10	9	3,4	400
CR 50 - 100/020/11	CS 50 - 100/020/11	50	0,20	30	30	15	11	4,5	100
* CR 50 - 150/020/11	* CS 50 - 150/020/11	50	0,20	30	30	15	11	4,5	150
* CR 50 - 200/020/11	* CS 50 - 200/020/11	50	0,20	30	30	15	11	4,5	200
* CR 50 - 250/020/11	* CS 50 - 250/020/11	50	0,20	30	30	15	11	4,5	250
* CR 50 - 300/020/11	* CS 50 - 300/020/11	50	0,20	30	30	15	11	4,5	300
CR 50 - 400/020/11	CS 50 - 400/020/11	50	0,20	30	30	15	11	4,5	400
CR 75 - 150/020/11	CS 75 - 150/020/11	75	0,20	30	30	15	11	5,0	150
CR 75 - 200/020/11	CS 75 - 200/020/11	75	0,20	30	30	15	11	5,0	200
CR 75 - 250/020/11	CS 75 - 250/020/11	75	0,20	30	30	15	11	5,0	250
CR 75 - 300/020/11	CS 75 - 300/020/11	75	0,20	30	30	15	11	5,0	300
CR 75 - 400/020/11	CS 75 - 400/020/11	75	0,20	30	30	15	11	5,0	400

\* Disponibile normalmente a magazzino

Le lunghezze, sezioni, forature non comprese in tabella vengono allestite su richiesta.

\* Material is usually in stock

The lengths, sections and drill sizes which are not mentioned in table above, can be manufactured upon request.

# COLLEGAMENTI FLESSIBILI IN TRECCIA PIATTA

## FLAT BRAIDED SHUNTS

- ▶ Terminali in tubo di rame stagnato, argentato su richiesta  
*Pressed copper connectors, tin coated or silver coated on request*
- ▶ Filo elementare / *Single wire Cu ETP UNI 1977-78:2000*  
0,20 standard  
0,10 su richiesta / *on request*

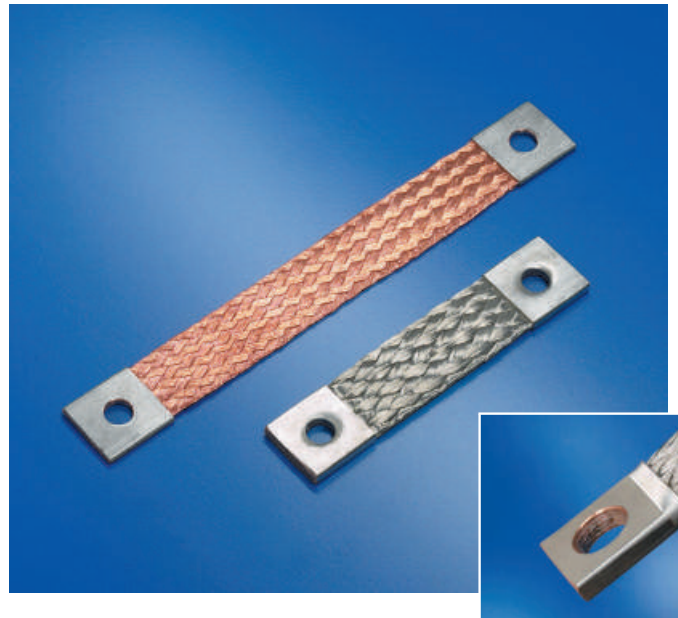
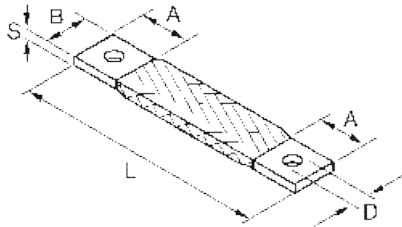

Rame rosso <i>Red copper</i>	Rame stagnato <i>Tinned copper</i>	Sezione mm <sup>2</sup> <i>Section</i>	A mm.	B mm.	S mm.	L mm.	Ø Fori D mm. <i>Holes D</i>	Foratura del terminale <i>Terminal Drill</i>	Portata max AC Amps <i>Ampacity</i>
CRS 10-200/10	CSS 10-200/10	10	10	10	3,5	200	5	W1	85
CRS 10-200/12	CSS 10-200/12	10	12	12	3,2	200	6	W1	85
CRS 16-200/15	CSS 16-200/15	16	15	15	3,5	200	7	W1	120
CRS 16-200/17	CSS 16-200/17	16	17	17	3,3	200	9	W1	120
CRS 25-200/20	CSS 25-200/20	25	20	20	3,7	200	9	W1	150
CRS 25-200/22	CSS 25-200/22	25	22	22	3,5	200	9	W1	150
CRS 25-200/25	CSS 25-200/25	25	25	25	3,3	200	11	W1	160
CRS 35-200/22	CSS 35-200/22	35	22	22	4,1	200	9	W1	190
CRS 35-200/25	CSS 35-200/25	35	25	25	3,8	200	11	W1	200
CRS 50-200/25	CSS 50-200/25	50	25	25	4,6	200	11	W1	260
CRS 50-200/30	CSS 50-200/30	50	30	30	4,2	200	13	W1	280
CRS 50-250/35	CSS 50-250/35	50	35	35	3,8	250	13	W1	300
CRS 75-200/30	CSS 75-200/30	75	30	30	5,2	200	13	W1	320
CRS 75-250/35	CSS 75-250/35	75	35	35	4,8	250	13	W1	330
CRS 100-200/30	CSS 100-200/30	100	30	30	6,3	200	13	W1	350
CRS 100-200/35	CSS 100-200/35	100	35	35	5,6	200	13	W1	360
CRS 100-250/40	CSS 100-250/40	100	40	40	5,2	250	13	W1	370
CRS 120-200/30	CSS 120-200/30	120	30	30	7,0	200	13	W1	400
CRS 120-200/35	CSS 120-200/35	120	35	35	6,5	200	13	W1	420
CRS 120-250/40	CSS 120-250/40	120	40	40	5,8	250	13	W1	450
CRS 150-200/30	CSS 150-200/30	150	30	30	8,4	200	13	W1	500
CRS 150-200/35	CSS 150-200/35	150	35	35	7,5	200	13	W1	520
CRS 150-250/40	CSS 150-250/40	150	40	40	6,8	250	13	W1	550
CRS 150-250/45	CSS 150-250/45	150	45	45	6,2	250	13	W1	570

TIPO DI  
FORATURA  
STANDARD  
DRILLINGS

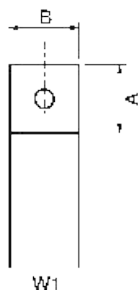

Larghezze, lunghezze, sezioni e forature non comprese in tabella vengono allestite su richiesta.

\* Le intensità ammissibili sono a titolo indicativo, esse dipendono dalle condizioni di installazione e di esercizio. Non possono implicare in nessun caso la responsabilità del costruttore.

*Widths, lengths, cross-sections and bores are not included in table above, they are provided at request.*

\* All information concerning current flow is not binding, the values shown above are approximate values. The manufacturer shall not be held responsible under any circumstance.

# COLLEGAMENTI FLESSIBILI IN TRECCIA PER FORTI INTENSITÀ HIGH CURRENT FLAT BRAIDED SHUNTS

- ▶ Terminali in tubo di rame stagnato, argentato su richiesta  
*Pressed copper connectors, tin coated or silver coated on request*

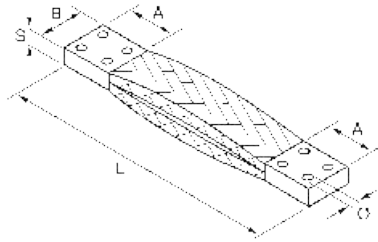

- ▶ Filo elementare | *Single wire*  
Cu ETP UNI 1977-78:2000  
0,20 standard  
0,10 su richiesta | *on request*

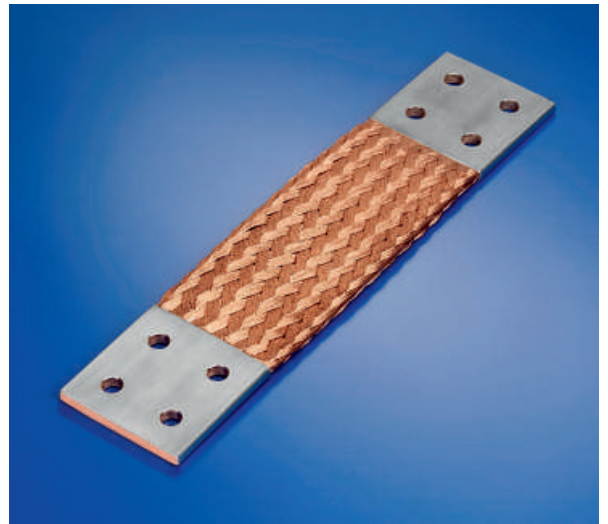

Rame rosso <i>Red copper</i>	Rame stagnato <i>Tinned copper</i>	Sezione mm <sup>2</sup> <i>Section</i>	A mm.	B mm.	S mm.	L mm.	Ø Fori D mm. <i>Holes D</i>	Foratura del terminale <i>Terminal Drill</i>	Portata max AC Amps <i>Ampacity</i>
CRS 200 - 250 / 40	CSS 200 - 250 / 40	200	40	40	8,3	250	13	W1	680
CRS 200 - 250 / 45	CSS 200 - 250 / 45	200	45	45	7,6	250	13	W1	720
CRS 200 - 250 / 50	CSS 200 - 250 / 50	200	50	50	7,0	250	13	W1	760
CRS 200 - 350 / 40	CSS 200 - 350 / 40	200	100	40	8,3	350	13	W2	680
CRS 200 - 350 / 50	CSS 200 - 350 / 50	200	100	50	7,0	350	13	W2	760
CRS 250 - 250 / 40	CSS 250 - 250 / 40	250	40	40	10,0	250	13	W1	780
CRS 250 - 250 / 45	CSS 250 - 250 / 45	250	45	45	9,0	250	13	W1	820
CRS 250 - 250 / 50	CSS 250 - 250 / 50	250	50	50	8,3	250	13	W1	870
CRS 250 - 350 / 40	CSS 250 - 350 / 40	250	100	40	10,0	350	13	W2	780
CRS 250 - 350 / 50	CSS 250 - 350 / 50	250	100	50	8,3	350	13	W2	870
CRS 300 - 300 / 45	CSS 300 - 300 / 45	300	45	45	10,6	300	13	W1	860
CRS 300 - 300 / 50	CSS 300 - 300 / 50	300	50	50	9,5	300	13	W1	920
CRS 300 - 300 / 60	CSS 300 - 300 / 60	300	60	60	9,3	300	13	W1	970
CRS 300 - 400 / 45	CSS 300 - 400 / 45	300	80	45	10,6	400	13	W2	860
CRS 300 - 400 / 50	CSS 300 - 400 / 50	300	100	50	9,5	400	13	W2	920
CRS 300 - 400 / 60	CSS 300 - 400 / 60	300	120	60	9,3	400	13	W3	970
CRS 300 - 400 / 70	CSS 300 - 400 / 70	300	120	70	8,4	400	13	W3	1020
CRS 400 - 300 / 50	CSS 400 - 300 / 50	400	50	50	12,0	300	13	W1	1020
CRS 400 - 400 / 40	CSS 400 - 400 / 40	400	80	40	15,0	400	13	W2	960
CRS 400 - 400 / 50	CSS 400 - 400 / 50	400	100	50	12,0	400	13	W2	1020
CRS 400 - 400 / 60	CSS 400 - 400 / 60	400	120	60	11,5	400	13	W3	1100
CRS 400 - 400 / 80	CSS 400 - 400 / 80	400	80	80	9,2	400	13	W4	1200
CRS 400 - 400 / 100	CSS 400 - 400 / 100	400	100	100	7,8	400	13	W5	1280
CRS 400 - 400 / 120	CSS 400 - 400 / 120	400	120	120	8,3	400	13	W7	1400
CRS 500 - 400 / 50	CSS 500 - 400 / 50	500	100	50	14,5	400	13	W2	1200
CRS 500 - 400 / 60	CSS 500 - 400 / 60	500	120	60	13,5	400	13	W3	1300
CRS 500 - 400 / 80	CSS 500 - 400 / 80	500	80	80	11,0	400	13	W4	1400
CRS 500 - 400 / 90	CSS 500 - 400 / 90	500	120	90	10,0	400	13	W4	1440
CRS 500 - 400 / 100	CSS 500 - 400 / 100	500	100	100	9,2	400	13	W5	1500
CRS 500 - 450 / 120	CSS 500 - 450 / 120	500	120	120	9,5	450	13	W7	1600
CRS 600 - 400 / 60	CSS 600 - 400 / 60	600	100	60	15,6	400	13	W2	1400
CRS 600 - 400 / 70	CSS 600 - 400 / 70	600	120	70	13,7	400	13	W3	1500
CRS 600 - 400 / 80	CSS 600 - 400 / 80	600	80	80	12,4	400	13	W4	1550
CRS 600 - 400 / 90	CSS 600 - 400 / 90	600	120	90	11,3	400	13	W4	1600
CRS 600 - 400 / 100	CSS 600 - 400 / 100	600	100	100	10,4	400	13	W5	1700
CRS 600 - 450 / 120	CSS 600 - 450 / 120	600	120	120	10,5	450	13	W7	1800
CRS 800 - 400 / 80	CSS 800 - 400 / 80	800	80	80	15,5	400	13	W4	1800
CRS 800 - 400 / 100	CSS 800 - 400 / 100	800	100	100	12,9	400	13	W5	1900
CRS 800 - 450 / 120	CSS 800 - 450 / 120	800	120	120	12,6	450	13	W7	2000
CRS 1000 - 450 / 80	CSS 1000 - 450 / 80	1000	80	80	18,6	450	13	W4	1900
CRS 1000 - 450 / 100	CSS 1000 - 450 / 100	1000	100	100	15,4	450	13	W5	2150
CRS 1000 - 500 / 120	CSS 1000 - 500 / 120	1000	120	120	15,0	500	13	W7	2300
CRS 1200 - 450 / 100	CSS 1200 - 450 / 100	1200	100	100	19,5	450	15	W5	2250
CRS 1200 - 450 / 120	CSS 1200 - 450 / 120	1200	120	120	17,0	450	15	W7	2400
CRS 1500 - 450 / 120	CSS 1500 - 450 / 120	1500	120	120	20,0	450	15	W7	2500
CRS 1800 - 450 / 120	CSS 1800 - 450 / 120	1800	120	120	23,5	450	15	W7	2600
CRS 2000 - 450 / 120	CSS 2000 - 450 / 120	2000	120	120	26,0	450	15	W7	2700

Larghezze, lunghezze, sezioni e forature non comprese in tabella vengono allestite su richiesta.

\* Le intensità ammissibili sono a titolo indicativo, esse dipendono dalle condizioni di installazione e di esercizio. Non possono implicare in nessun caso la responsabilità del costruttore.

Widths, lengths, sections and bores are not included in table above, they are provided at request.

\* All information concerning ampacity is not binding, the values shown above are approximate values. The manufacturer shall not be held responsible under any circumstance.

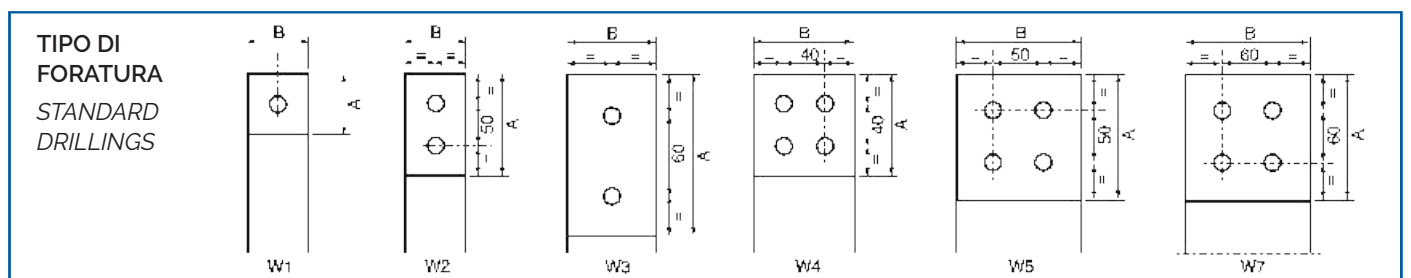



# COLLEGAMENTI FLESSIBILI IN TRECCIA PER FORTI INTENSITÀ con terminali larghi

## HIGH CURRENT FLAT BRAIDED SHUNTS for large transformer links

- ▶ Terminali in tubo di rame stagnato, argentato su richiesta  
*Pressed copper connectors, tin coated or silver coated on request*

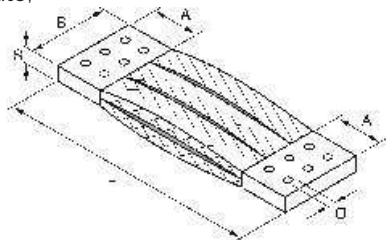

- ▶ Filo elementare | *Single wire*  
0,20 standard  
0,10 su richiesta | *on request*

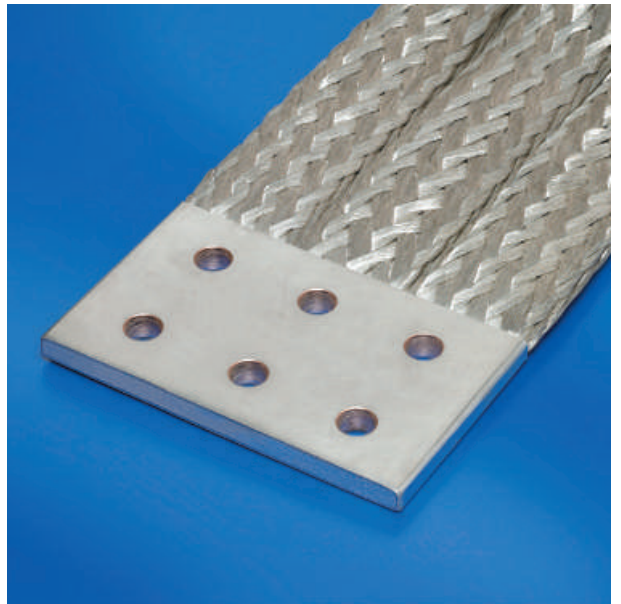

Rame rosso <i>Red copper</i>	Rame stagnato <i>Tinned copper</i>	Sezione mm <sup>2</sup> <i>Section</i>	A mm.	B mm.	S mm.	L mm.	Ø Fori D mm. <i>Holes D</i>	Foratura del terminale <i>Terminal Drill</i>	Portata max AC Amps <i>Ampacity</i>
CRS 800-450/150	CSS 800-450/150	800	120	150	10,5	450	13	W7	2200
CRS 800-450/160	CSS 800-450/160	800	120	160	11,5	450	13	W8	2400
CRS 800-500/180	CSS 800-500/180	800	120	180	10,5	500	13	W8	2500
CRS 800-500/200	CSS 800-500/200	800	120	200	11,0	500	13	W9	2700
CRS 1000-500/150	CSS 1000-500/150	1000	120	150	12,0	500	13	W7	2400
CRS 1000-500/160	CSS 1000-500/160	1000	120	160	13,0	500	13	W8	2500
CRS 1000-500/180	CSS 1000-500/180	1000	120	180	12,0	500	13	W8	2650
CRS 1000-500/200	CSS 1000-500/200	1000	120	200	12,5	500	13	W9	2800
CRS 1200-500/150	CSS 1200-500/150	1200	120	150	15,0	500	13	W7	2500
CRS 1200-500/160	CSS 1200-500/160	1200	120	160	14,5	500	13	W8	2650
CRS 1200-500/180	CSS 1200-500/180	1200	120	180	13,5	500	13	W8	2800
CRS 1200-500/200	CSS 1200-500/200	1200	120	200	13,5	500	13	W9	3000
CRS 1500-500/150	CSS 1500-500/150	1500	120	150	17,5	500	15	W7	2700
CRS 1500-500/160	CSS 1500-500/160	1500	120	160	16,5	500	15	W8	2900
CRS 1500-500/180	CSS 1500-500/180	1500	120	180	15,5	500	15	W8	3000
CRS 1500-500/200	CSS 1500-500/200	1500	120	200	15,5	500	15	W9	3100
CRS 1800-500/150	CSS 1800-500/150	1800	120	150	20,0	500	15	W7	2850
CRS 1800-500/160	CSS 1800-500/160	1800	120	160	19,0	500	15	W8	3000
CRS 1800-500/180	CSS 1800-500/180	1800	120	180	17,5	500	15	W8	3200
CRS 1800-500/200	CSS 1800-500/200	1800	120	200	17,0	500	15	W9	3300
CRS 2000-500/150	CSS 2000-500/150	2000	120	150	21,5	500	15	W7	3100
CRS 2000-500/160	CSS 2000-500/160	2000	120	160	20,5	500	15	W8	3200
CRS 2000-500/180	CSS 2000-500/180	2000	120	180	19,0	500	15	W8	3400
CRS 2000-500/200	CSS 2000-500/200	2000	120	200	18,5	500	15	W9	3500
CRS 2000-600/220	CSS 2000-600/220	2000	140	220	17,5	600	15	W9	3600
CRS 2500-500/150	CSS 2500-500/150	2500	120	150	25,5	500	15	W7	3200
CRS 2500-500/160	CSS 2500-500/160	2500	120	160	24,5	500	15	W8	3400
CRS 2500-500/180	CSS 2500-500/180	2500	120	180	22,0	500	15	W8	3600
CRS 2500-500/200	CSS 2500-500/200	2500	120	200	20,5	500	15	W9	3800
CRS 2500-600/220	CSS 2500-600/220	2500	140	220	19,0	600	15	W9	4000
CRS 3000-500/150	CSS 3000-500/150	3000	120	150	30,0	500	15	W7	3500
CRS 3000-500/160	CSS 3000-500/160	3000	120	160	28,5	500	15	W8	3700
CRS 3000-500/180	CSS 3000-500/180	3000	120	180	27,0	500	15	W8	3900
CRS 3000-500/200	CSS 3000-500/200	3000	120	200	23,5	500	15	W9	4000
CRS 3000-600/220	CSS 3000-600/220	3000	140	220	22,0	600	15	W9	4200

Larghezze, lunghezze, sezioni e forature non comprese in tabella vengono allestite su richiesta.

\* Le intensità ammissibili sono a titolo indicativo, esse dipendono dalle condizioni di installazione e di esercizio. Non possono implicare in nessun caso la responsabilità del costruttore.

Per le forature standard tipo W vedi pag. 19.

Widths, lengths, sections and bores are not included in table above, they are provided at request.

\* All information concerning ampacity is not binding, the values shown above are approximate values. The manufacturer shall not be held responsible under any circumstance.

See page 19 for standard drillings type W.

# COLLEGAMENTI FLESSIBILI IN TRECCIA PER FORTI INTENSITÀ

## con terminali allungati ad attacco contenuto

### HIGH CURRENT FLAT BRAIDED SHUNTS with extended reduced terminals

► Terminali in tubo di rame argentato o stagnato  
*Pressed copper ferrules silver or tin coated*

► Filo elementare: 0,20 rame stagnato  
*Single wire: 0,20 tinned copper*

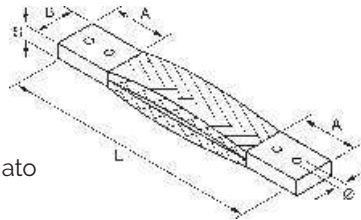

Terminali argentati <i>Silver coated ferrules</i>	Terminali stagnati <i>Tin coated ferrules</i>	Sezione mm <sup>2</sup> <i>Section</i>	A mm.	B mm.	S mm.	L mm.	Ø Fori D mm. <i>Holes D</i>	Foratura del terminale <i>Terminal Drill</i>	Portata max AC Amps <i>Ampacity</i>
CSA 300-400/35	CSS 300-400/35	300	100	35	16,0	400	13	W2X40	800
CSA 300-400/40	CSS 300-400/40	300	100	40	14,5	400	13	W2X40	850
CSA 300-400/45	CSS 300-400/45	300	100	45	13,5	400	13	W2X40	900
CSA 300-400/50	CSS 300-400/50	300	100	50	12,5	400	13	W2X50	950
CSA 400-400/35	CSS 400-400/35	400	100	35	20,0	400	13	W2X40	850
CSA 400-400/40	CSS 400-400/40	400	100	40	17,0	400	13	W2X40	900
CSA 400-400/45	CSS 400-400/45	400	100	45	16,0	400	13	W2X40	950
CSA 400-400/50	CSS 400-400/50	400	100	50	14,5	400	13	W2X50	1000
CSA 500-400/40	CSS 500-400/40	500	100	40	21,0	400	13	W2X40	1000
CSA 500-400/45	CSS 500-400/45	500	100	45	19,0	400	13	W2X40	1100
CSA 500-400/50	CSS 500-400/50	500	100	50	17,5	400	13	W2X50	1200
CSA 500-450/55	CSS 500-450/55	500	120	55	16,0	450	13	W2X60	1300
CSA 600-400/40	CSS 600-400/40	600	100	40	24,5	400	13	W2X40	1100
CSA 600-400/45	CSS 600-400/45	600	100	45	22,0	400	13	W2X40	1150
CSA 600-400/50	CSS 600-400/50	600	100	50	20,5	400	13	W2X50	1200
CSA 600-450/55	CSS 600-450/55	600	120	55	19,0	450	13	W2X60	1300
CSA 600-450/60	CSS 600-450/60	600	120	60	17,5	450	13	W2X60	1400
CSA 700-400/40	CSS 700-400/40	700	100	40	28,0	400	13	W2X40	1150
CSA 700-400/45	CSS 700-400/45	700	100	45	25,5	400	13	W2X40	1250
CSA 700-400/50	CSS 700-400/50	700	100	50	23,0	400	13	W2X50	1350
CSA 700-450/55	CSS 700-450/55	700	120	55	21,5	450	13	W2X60	1450
CSA 700-450/60	CSS 700-450/60	700	120	60	20,0	450	13	W2X60	1550
CSA 800-400/40	CSS 800-400/40	800	100	40	36,0	400	13	W2X40	1250
CSA 800-400/45	CSS 800-400/45	800	100	45	32,0	400	13	W2X40	1350
CSA 800-400/50	CSS 800-400/50	800	100	50	28,5	400	13	W2X50	1450
CSA 800-450/55	CSS 800-450/55	800	120	55	26,5	450	13	W2X60	1600
CSA 800-450/60	CSS 800-450/60	800	120	60	24,5	450	13	W2X60	1700
CSA 900-400/40	CSS 900-400/40	900	100	40	37,0	400	13	W2X40	1350
CSA 900-400/45	CSS 900-400/45	900	100	45	33,5	400	13	W2X40	1450
CSA 900-400/50	CSS 900-400/50	900	100	50	30,0	400	13	W2X50	1600
CSA 900-450/55	CSS 900-450/55	900	120	55	27,5	450	13	W2X60	1700
CSA 900-450/60	CSS 900-450/60	900	120	60	25,5	450	13	W2X60	1800
CSA 1000-450/50	CSS 1000-450/50	1000	100	50	33,0	450	13	W2X50	1700
CSA 1000-450/55	CSS 1000-450/55	1000	120	55	30,0	450	13	W2X60	1800
CSA 1000-500/60	CSS 1000-500/60	1000	120	60	28,0	500	13	W2X60	1850
CSA 1000-500/70	CSS 1000-500/70	1000	120	70	24,0	500	13	W2X60	1900

Larghezze, lunghezze, sezioni e forature non comprese in tabella vengono allestite su richiesta.

\* Le intensità ammissibili sono a titolo indicativo, esse dipendono dalle condizioni di installazione e di esercizio. Non possono implicare in nessun caso la responsabilità del costruttore.

Per le forature standard tipo W vedi pag. 19.

Widths, lengths, sections and bores are not included in table above, they are provided at request.

\* All information concerning ampacity is not binding, the values shown above are approximate values. The manufacturer shall not be held responsible under any circumstance.

See page 19 for standard drillings type W.

# Caratteristiche principali dei flessibili in treccia con terminali in tubo di rame pressato

## Main characteristics of braided shunt with pressed copper connectors

Sezione mm <sup>2</sup> Section	A mm.	B mm.	S mm. ca.	Portata massima A   Ampacity			
				50 Hz	200 Hz	1000 Hz	DC
25	20	20	3,7	150	140	130	150
50	20	20	5	250	230	200	250
75	20	20	7	340	310	270	350
100	20	20	9	370	340	300	380
75	30	30	5,2	390	360	340	400
100	30	30	6	440	420	380	450
150	30	30	8	540	510	420	550
100	40	40	5,2	480	440	400	500
150	40	40	6,8	590	540	480	600
200	40	40	8	680	630	500	700
250	40	40	10	780	690	550	800
150	50	50	6	640	590	540	660
200	50	50	7	760	700	610	780
250	50	50	8,3	870	800	630	920
300	50	50	10,6	920	830	750	950
200	60	60	6	830	760	680	880
250	60	60	7	900	830	650	950
300	60	60	8,5	970	870	620	1020
400	60	60	11,5	1100	980	780	1150
400	80	80	9,5	1200	910	670	1350
500	80	80	11	1400	1250	950	1500
600	80	80	12,5	1550	1350	980	1650
800	80	80	15,5	1800	1500	1100	1900
600	100	100	11,5	1700	1550	1150	1800
800	100	100	14	1900	1680	1200	1950
1000	100	100	16,5	2150	1850	1300	2300
1000	120	120	14,4	2300	2000	1400	2400
1200	120	120	16,5	2400	2150	1300	2500
1500	120	120	20	2500	2200	1400	2600
1800	120	150	20	2850	2450	1500	2950
2000	120	160	21	3200	2700	1600	3300
2500	120	180	23,50	3600	2900	1750	3700
3000	140	200	27	4000	3100	1900	4200
4000	140	220	34	5000	3300	2100	5300

La tabella è indicativa, le dimensioni sono di massima e rappresentano tipologie costruttive non impegnative. I valori delle portate sono approssimati.

The table above is indicative, the dimensions indicated are to be considered approximated. The ampacity's values shown above have been approximated.

### TERMINALI PRESSATI



Le estremità delle trecce sono inserite in un tubo di rame stagnato e pressato a forte pressione in uno stampo di calibratura. La compattezza raggiunge l'80% e di conseguenza non è necessario stagnare a caldo l'interno dei terminali di contatto; questa operazione viene eseguita per applicazioni speciali, solamente su richiesta.

Lo spessore dei terminali nelle tabelle è indicativo, la formazione a treccia singola o multipla sovrapposta può comportare variazione dello spessore.

**Sezione minima dei flessibili:** è consigliabile dimensionare i flessibili con sezione minima non inferiore all'80% della sezione delle barre piene (norma DIN 46276).

### PRESSED TERMINALS

The braided ends are inserted into a tinned copper tube and then pressed at high pressure, by a die, in order to obtain the correct size. It is compacted to 80% therefore it is not necessary to tin the internal part of the contact at a hot temperature; this operation is performed only for special applications, and at request.

The terminal's thickness indicated in the tables is approximate and it may result varied by the single or multiple superimposed braids.

**Minimum cross-section:** it is suggested to use a minimum cross-section which is not less than 80% of the actual solid bar's section (DIN 46276 specifications).

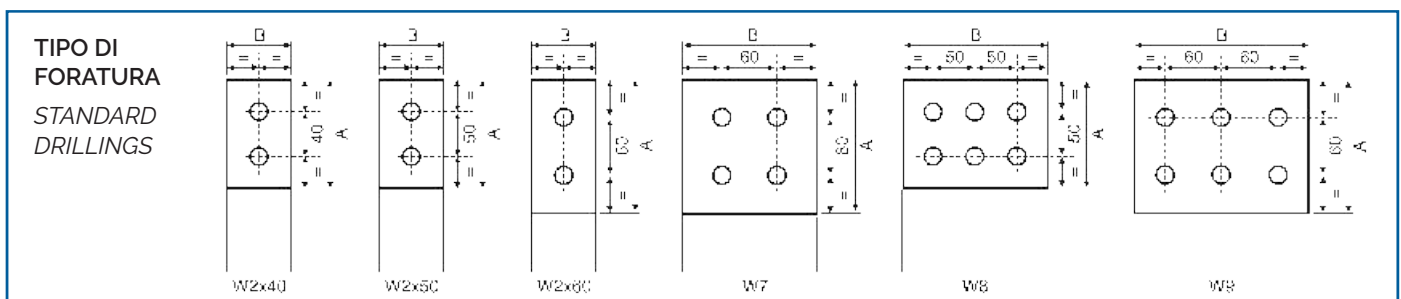

# Come possiamo costruire un flessibile

## How we can manufacture the flexible power link

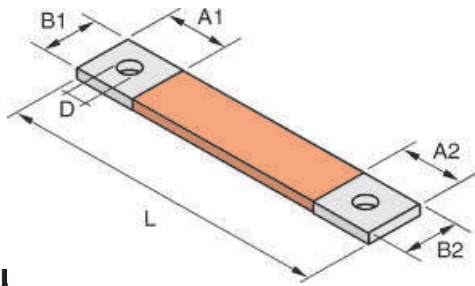

Type **U**

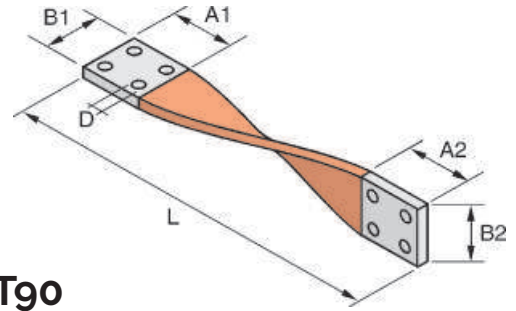

Type **T90**

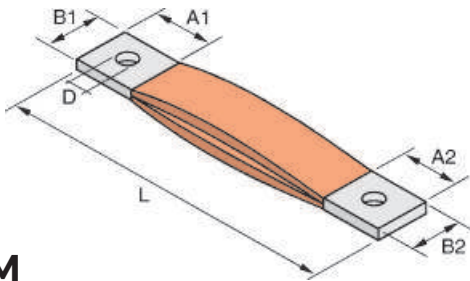

Type **M**

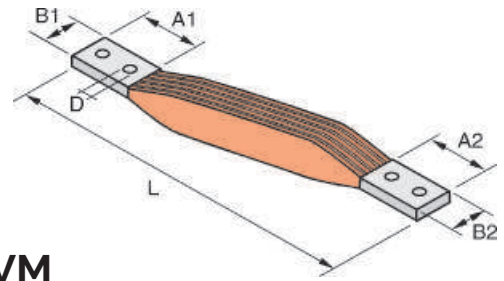

Type **VM**

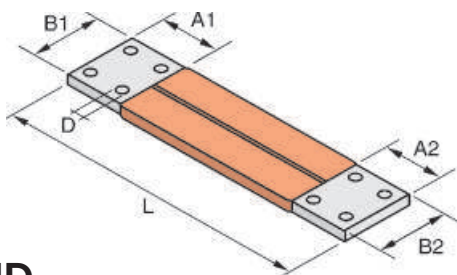

Type **UD**

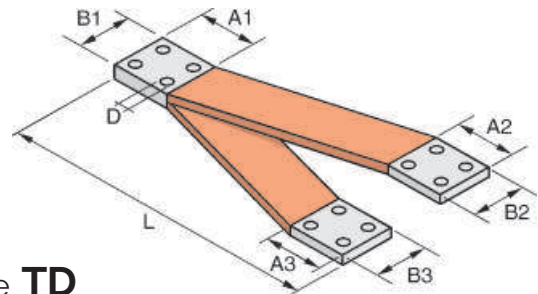

Type **TD**

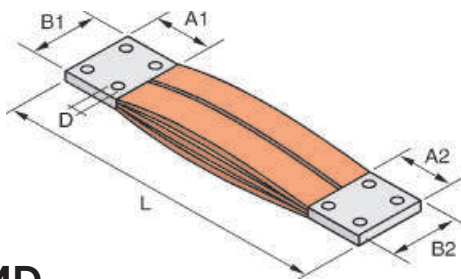

Type **MD**

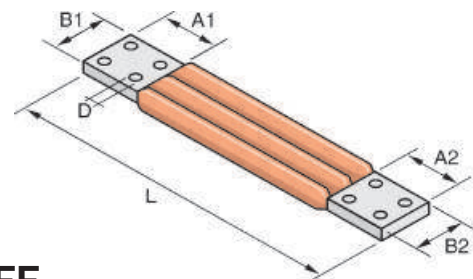

Type **FF**

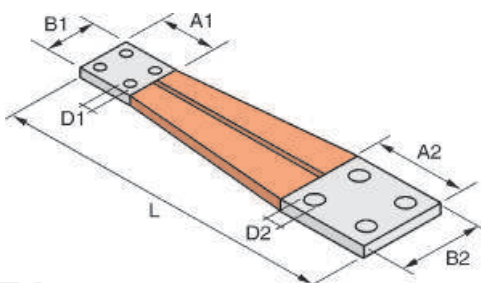

Type **TV**

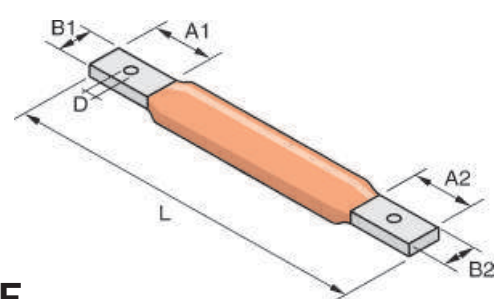

Type **F**

# COLLEGAMENTI FLESSIBILI IN TRECCIA ROTONDA O CORDA

## ROUND BRAIDED SHUNTS

► Terminali in tubo di rame stagnato, argentato su richiesta  
*Pressed copper connectors, tin coated or silver coated on request*

► Filo elementare  
*Single wire*  
Cu ETP UNI 1977-78:2000  
0,20 standard  
0,10 su richiesta | *on request*

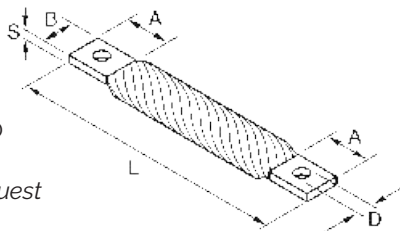

Rame rosso <i>Red copper</i>	Rame stagnato <i>Tinned copper</i>	Sezione mm <sup>2</sup> <i>Section</i>	A mm.	B mm.	S mm.	L mm.	Ø Fori D mm. <i>Holes D</i>	Foratura del terminale <i>Terminal Drill</i>	Portata max AC Amps <i>Ampacity</i>
COR 75/020-200/30	COS 75/020-200/30	75	30	30	5,2	200	11	W1	300
COR 100/020-250/30	COS 100/020-250/30	100	30	30	6,0	250	11	W1	370
COR 150/020-300/35	COS 150/020-300/35	150	35	35	7,5	300	13	W1	480
	CCS 150/020-300/35	150	35	35	7,5	300	13	W1	480
	CCS 200/020-300/40	200	40	40	8,3	300	13	W1	610
	CCS 250/020-300/40	250	40	40	10,0	300	13	W1	700
	CCS 300/020-400/40	300	40	40	10,6	400	13	W1	780
	CCR 300/010-400/40		300	40	40	10,6	400	13	W1
CCR 400/010-400/50		400	50	50	12,0	400	13	W1	950
CCR 500/010-500/50		500	50	50	16,0	500	13	W1	1100
CCR 600/010-500/50		600	50	50	17,5	500	13	W1	1250
	CCS 2x150/020-400/40	300	40	40	10,6	400	13	W1	900
	CCS 2x200/020-400/50	400	50	50	12,0	400	13	W1	1150
	CCS 2x250/020-500/50	500	50	50	16,0	500	13	W1	1300
	CCS 2x300/020-500/60	600	60	60	17,5	500	13	W1	1450
	CCS 4x150/020-400/80	600	80	80	12,5	400	13	W4	1500
	CCS 4x200/020-400/80	800	80	80	15,5	400	13	W4	1650
	CCS 4x250/020-500/100	1000	100	100	16,5	500	13	W5	1850
	CCS 4x300/020-500/120	1200	120	120	16,5	500	13	W7	2100

Larghezze, lunghezze, sezioni e forature non comprese in tabella vengono allestite su richiesta.

### ISOLAMENTO SPECIALE A RICHIESTA

- Fibra vetro HVR
- Tubo gomma CNOMO HKR
- Silicone grigio RHO
- Silicone nero SYL
- Poliolefina nera PLF

\* Le intensità ammissibili sono a titolo indicativo, esse dipendono dalle condizioni di installazione e di esercizio. Non possono implicare in nessun caso la responsabilità del costruttore.

Ridurre la portata dei flessibili del 15-25% se sono isolati.

Widths, lengths, sections and bores are not included in table above, they are provided at request.

### SPECIAL INSULATION UPON REQUEST

- Fiber-glass HVR
- Rubber tube HKR
- Greysilicon RHO
- Black silicon SYL
- Black polyolefin PLF

\* All information concerning ampacity is not binding, the values shown above are approximate values. The manufacturer shall not be held responsible under any circumstance.

The ampacity will be reduced by using insulated shunts.

### TIPO DI FORATURA STANDARD DRILLINGS

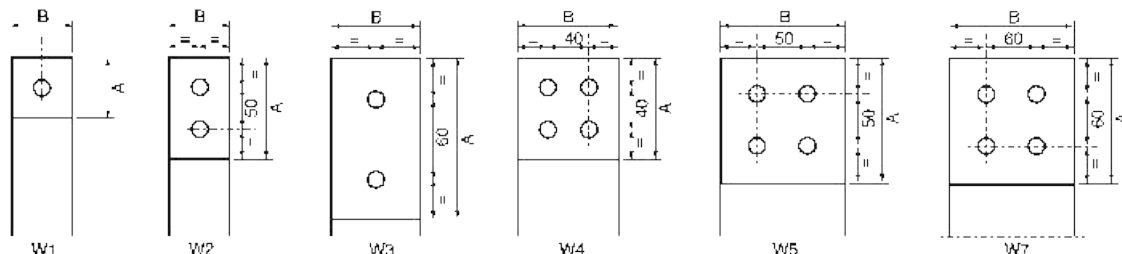

# FLESSIBILI RAFFREDDATI AD ARIA con e senza isolamento

## AIR COOLED HIGH CURRENT CABLES with and without insulation

- ▶ Terminali in tubo di rame stagnato  
*Pressed copper connectors, tin coated*
- ▶ Filo elementare | *Single wire* Cu ETP UNI EN 1977-78:2000  
0,10 or 0,20mm

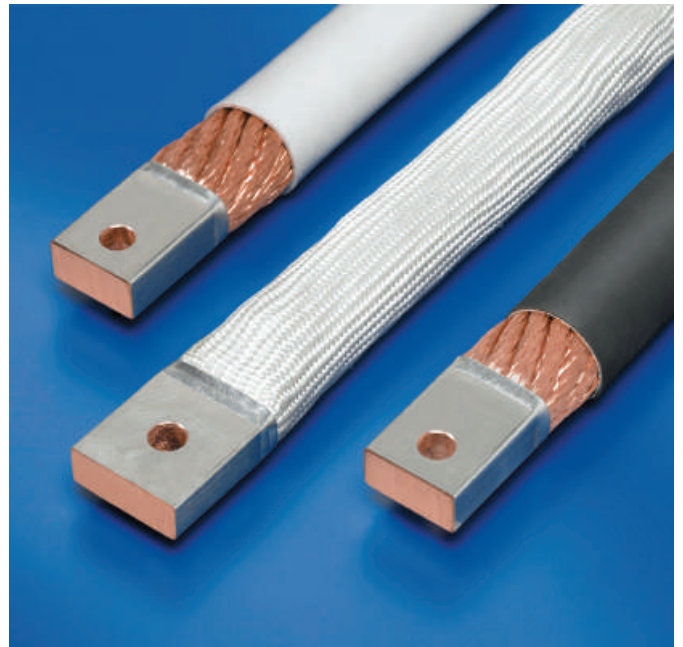
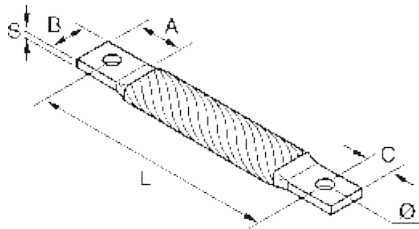

Rame rosso <i>Red copper</i>	Sezione mm <sup>2</sup> <i>Section</i>	Ø Filo <i>Wire dia.</i>	A mm.	B mm.	C mm.	Ø mm.	S mm.	L mm.
CCR 300-250 / 32	300	0,10	50	32	16	13	17,0	250
CCR 300-300 / 32	300	0,10	50	32	16	13	17,0	300
CCR 300-350 / 32	300	0,10	50	32	16	13	17,0	350
CCR 300-400 / 32	300	0,10	50	32	16	13	17,0	400
CCR 300-450 / 32	300	0,10	50	32	16	13	17,0	450
CCR 300-500 / 32	300	0,10	50	32	16	13	17,0	500
CCR 400-250 / 32	400	0,10	50	32	16	13	20,5	250
CCR 400-300 / 32	400	0,10	50	32	16	13	20,5	300
CCR 400-350 / 32	400	0,10	50	32	16	13	20,5	350
CCR 400-400 / 32	400	0,10	50	32	16	13	20,5	400
CCR 400-450 / 32	400	0,10	50	32	16	13	20,5	450
CCR 400-500 / 32	400	0,10	50	32	16	13	20,5	500
CCR 500-300 / 32	500	0,10	50	32	16	13	24,5	300
CCR 500-350 / 32	500	0,10	50	32	16	13	24,5	350
CCR 500-400 / 32	500	0,10	50	32	16	13	24,5	400
CCR 500-450 / 32	500	0,10	50	32	16	13	24,5	450
CCR 500-500 / 32	500	0,10	50	32	16	13	24,5	500
CCR 500-600 / 32	500	0,10	50	32	16	13	24,5	600
CCR 600-400 / 40	600	0,10	50	40	16	13	23,0	400
CCR 600-450 / 40	600	0,10	50	40	16	13	23,0	450
CCR 600-500 / 40	600	0,10	50	40	16	13	23,0	500
CCR 600-550 / 40	600	0,10	50	40	16	13	23,0	550
CCR 600-600 / 40	600	0,10	50	40	16	13	23,0	600
CCR 600-700 / 40	600	0,10	50	40	16	13	23,0	700

Larghezze, lunghezze, sezioni e forature non comprese in tabella vengono allestite su richiesta.

#### ISOLAMENTO A RICHIESTA

- Fibra vetro HVR
- Tubo gomma CNOMO HKR
- Silicone grigio RHO
- Poliolefina nera PLF

Widths, lengths, sections and bores are not included in table above, they are provided at request.

#### INSULATION UPON REQUEST

- Fibre-glass HVR
- Rubber tube HKR
- Grey silicon RHO
- Black polyolefin PLF

# TRECCE DI MASSA ROTONDE

## ROUND GROUNDING STRIPS

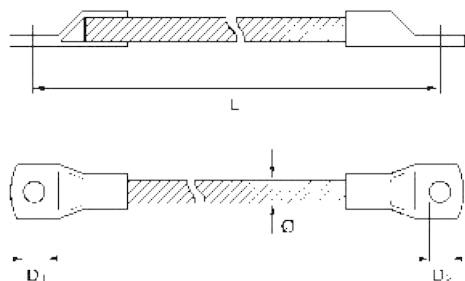

### Treccia rotonda | Round braid

Rame rosso <i>Red copper</i>		Rame stagnato <i>Tinned copper</i>		Sezione mm <sup>2</sup> <i>Section</i>	Ø Filo <i>Wire dia.</i>	L mm.	D <sub>1</sub> mm.	D <sub>2</sub> mm.	Ø mm.
COR	6/010 - 150/M6	COS	6/010 - 150/M6	6	0,10	150	6,4	6,4	4,0
COR	10/020 - 200/M6	COS	10/020 - 200/M6	10	0,20	200	6,4	6,4	5,0
COR	16/020 - 200/M8	COS	16/020 - 200/M8	16	0,20	200	8,4	8,4	6,6
COR	25/020 - 200/M8	COS	25/020 - 200/M8	25	0,20	200	8,4	8,4	7,6
COR	35/020 - 250/M10	COS	35/020 - 250/M10	35	0,20	250	10,5	10,5	9,5
COR	50/020 - 250/M10	COS	50/020 - 250/M10	50	0,20	250	10,5	10,5	11,5
COR	75/020 - 300/M12	COS	75/020 - 300/M12	75	0,20	300	13,2	13,2	13,7
COR	100/020 - 300/M12	COS	100/020 - 300/M12	100	0,20	300	13,2	13,2	16,0

### Corda | Twisted cable (rope)

Rame rosso <i>Red copper</i>		Rame stagnato <i>Tinned copper</i>		Sezione mm <sup>2</sup> <i>Section</i>	Ø Filo <i>Wire dia.</i>	L mm.	D <sub>1</sub> mm.	D <sub>2</sub> mm.	Ø mm.
CCR	10/010 - 200/M6	CCS	10/010 - 200/M6	10	0,10	200	6,4	6,4	5,0
CCR	16/010 - 200/M8	CCS	16/010 - 200/M8	16	0,10	200	8,4	8,4	6,6
CCR	25/010 - 200/M8	CCS	25/010 - 200/M8	25	0,10	200	8,4	8,4	7,6
CCR	35/010 - 250/M10	CCS	35/010 - 250/M10	35	0,10	250	10,5	10,5	9,5
CCR	50/010 - 250/M10	CCS	50/010 - 250/M10	50	0,10	250	10,5	10,5	11,5
CCR	75/010 - 300/M12	CCS	75/010 - 300/M12	75	0,10	300	13,2	13,2	13,7
CCR	100/020 - 350/M12	CCS	100/020 - 350/M12	100	0,20	350	13,2	13,2	16,0
CCR	120/020 - 350/M12	CCS	120/020 - 350/M12	120	0,20	350	13,2	13,2	17,5
CCR	150/020 - 350/M12	CCS	150/020 - 350/M12	150	0,20	350	13,2	13,2	19,0
CCR	200/020 - 400/M14	CCS	200/020 - 400/M14	200	0,20	400	15,0	15,0	24,0
CCR	240/020 - 400/M14	CCS	240/020 - 400/M14	240	0,20	400	15,0	15,0	26,0

### Corde sottotreccia

#### Round stranded copper cables with overall copper braid

Rame rosso <i>Red copper</i>		Rame stagnato <i>Tinned copper</i>		Sezione mm <sup>2</sup> <i>Section</i>	Ø Filo <i>Wire dia.</i>	L mm.	D <sub>1</sub> mm.	D <sub>2</sub> mm.	Ø mm.
CCR/CR	38/020 - 300/M8	CCS/CS	38/020 - 300/M8	38	0,20	300	8,4	8,4	9,5
CCR/CR	50/020 - 300/M8	CCS/CS	50/020 - 300/M8	50	0,20	300	8,4	8,4	11,5
CCR/CR	100/020 - 350/M10	CCS/CS	100/020 - 350/M10	100	0,20	350	10,5	10,5	16,0

Larghezze, lunghezze, sezioni e forature non comprese in tabella vengono allestite su richiesta.

ISOLAMENTO SPECIALE: pvc trasparente su richiesta.

Widths, lengths, sections and bores are not included in table above, they are provided at request.

SPECIAL INSULATION: transparent pvc-jacket are provided at request.

# TRECCE DI MASSA IN ALLUMINIO

## ALUMINIUM EARTHING STRAPS

- ▶ Terminali in lamiera di alluminio  
*Aluminium connecting pads*
- ▶ Filo elementare | *Single wire*:  
Aluminium 1050 A / EN-AW1370
- ▶ **UTILIZZO:** collegamenti equipotenziali di pannelli fotovoltaici per evitare fenomeni di elettrocorrosione.

**USABLE FOR:** solar panel equipotential link, withstand at the electrocorrosion

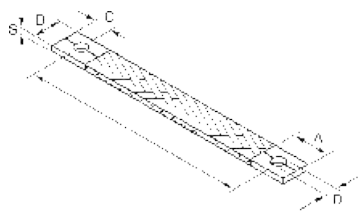

Terminale diritto D  
Standard terminal D

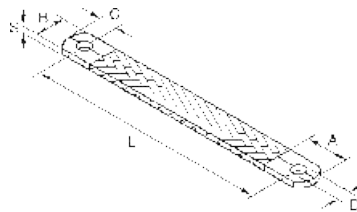

Terminale raggato T  
Curved terminal T

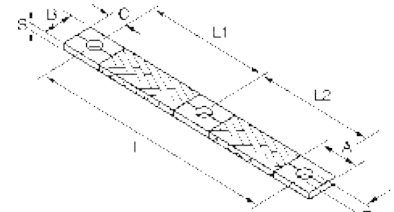

Terminale diritto D  
Standard terminal D

	Value	Tolerance	
<b>Flat braid uncoated aluminium:</b>			
nominal section	16,0 mm <sup>2</sup>		
single wire diameter	0,30mm	-0,001 / +0,003mm	
construction (crossing 53 x dm ± 3mm)	32x7x0,30		
dimensions	15x2,5mm	width ± 0,5mm	
<b>Earthing connection:</b>			
Hole to hole lenght (dimension L)	150mm	± 1,0mm	
Diameter of the holes (dimension D)	7mm	± 0,5mm	
Connecting pads (dimensions BxA)	17x23mm	± 0,5mm	
<b>Conductor characteristics:</b>			
			- Aluminium braid EN-AW1370 (1050A)
			- Aluminium strip EN-AW1370 (1050A H18)
<b>USABLE FOR:</b>			
			Photovoltaics module PV modules
			Solar panel equipotential link withstand at the electrocorrosion

Aluminium	Sezione mm <sup>2</sup> Section	Ø Filo Wire dia.	A mm.	B mm.	C mm.	D mm.	S mm.	L mm.	L1/L2 mm.
CA16-100/030/07	16	0,30	23	17	10	7	3,0	100	-
CA16-150/030/07	16	0,30	23	17	10	7	3,0	150	-
CA16-200/030/07	16	0,30	23	17	10	7	3,0	200	-
CA16-100+100/030/07	16	0,30	23	17	10	7	3,0	200	100
CA16-150+150/030/07	16	0,30	23	17	10	7	3,0	300	150
CA16-200+200/030/07	16	0,30	23	17	10	7	3,0	400	200

Larghezze, lunghezze, sezioni e forature non comprese in tabella vengono allestite su richiesta.

ISOLAMENTO A RICHIESTA: • Silicone SYL  
• Poliolefina nera PLF

Widths, lengths, sections and bores are not included in table above, they are provided at request.

INSULATION UPON REQUEST: • Silicon SYL  
• Black polyolefin PLF

# TRECCE DI MASSA SPECIALI

## SPECIAL GROUNDING STRIPS

- ▶ Allestimento su richiesta | *Manufactured upon request*

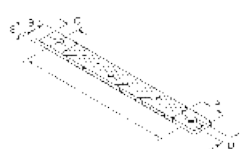

Terminale diritto D  
Standard terminal D



Terminale raggato T  
Curved terminal T



Terminale a forcella F  
Fork terminal F

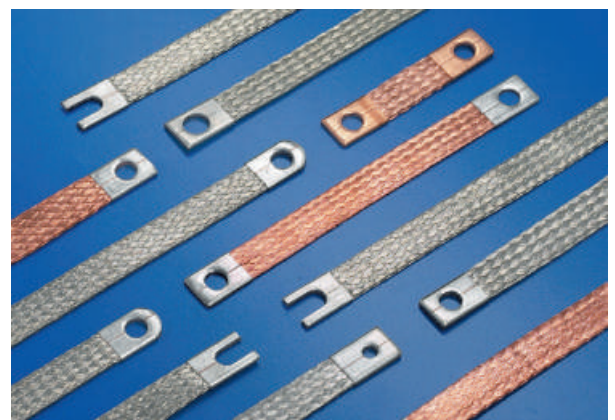



# LAMELLARI PRESSOSALDATI secondo DIN 46276

## PRESS WELDED SHUNTS similar to DIN 46276

- ▶ Terminali pressosaldati tipo PWR  
*Contact areas: PWR press-welded*
- ▶ Lamine standard: 0,3 mm Cu A1/H14  
*Copper strips: 0,3 mm Cu A1/H14*
- ▶ SU RICHIESTA: 0,1 mm con lamine esterne antilacerazione 0,3 mm  
*AT REQUEST: 0,1 mm thick with cover sheet 0,3 mm*
- ▶ Eventuale stagnatura o argentatura della sola superficie di contatto.  
*It is also possible to deliver contact areas with tinned or silvered design.*

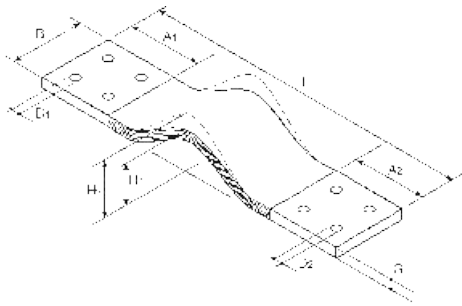

### NOTE SULLA PRESSOSALDATURA

Realizzabili solamente in esecuzione rame rosso in accordo alle dimensioni e alle specifiche del cliente.  
Le lamine vengono compresse e ricostruite in un unico blocco nella parte terminale mediante forte passaggio di corrente.  
La resistenza di contatto fra le singole lamine è pressoché nulla.

### NOTES REGARDING PRESS WELDING

Press welding can only be performed on red copper and it depends on its dimensions and customer specifications.  
The laminated sections are compressed and reconstructed by block during the terminal phase, via use of high currents.  
The contact resistance between each lamina is almost zero.

Rame rosso <i>Red copper</i>	Sezione mm <sup>2</sup> <i>Section</i>	A mm.	B mm.	S mm.	L mm.	H mm.	Ø Fori D mm. <i>Holes D</i>	Foratura del terminale <i>Terminal drill</i>	Portata max AC Amps <i>Ampacity</i>
PWR 200 / 180 / 40	200	50	40	5	180	40	13	W1	600
PWR 200 / 230 / 40	200	50	40	5	230	40	13	W1	600
PWR 320 / 230 / 40	320	50	40	8	230	43	13	W1	800
PWR 400 / 230 / 40	400	50	40	10	230	45	13	W1	900
PWR 250 / 250 / 50	250	60	50	5	250	45	13	W1	700
PWR 400 / 250 / 50	400	60	50	8	250	48	13	W1	950
PWR 500 / 250 / 50	500	60	50	10	250	50	13	W1	1100
PWR 480 / 300 / 60	480	90	60	8	300	70	13	W2	1100
PWR 600 / 300 / 60	600	90	60	10	300	70	13	W2	1200
PWR 640 / 300 / 80	640	90	80	8	300	70	13	W4	1350
PWR 800 / 300 / 80	800	90	80	10	300	70	13	W4	1500
PWR 960 / 300 / 80	960	90	80	12	300	70	13	W4	1700
PWR 800 / 350 / 100	800	110	100	8	350	80	13	W5	1550
PWR 1000 / 350 / 100	1000	110	100	10	350	80	13	W5	1800
PWR 1200 / 350 / 100	1200	110	100	12	350	80	13	W5	1900
PWR 1200 / 400 / 120	1200	130	120	10	400	80	13	W7	2000
PWR 1500 / 400 / 120	1500	130	120	12,5	400	80	13	W7	2300
PWR 1800 / 450 / 120	1800	130	120	15	450	80	15	W7	2500
PWR 2000 / 450 / 120	2000	130	120	16,8	450	80	15	W7	2750
PWR 2400 / 450 / 120	2400	130	120	20	450	80	15	W7	2900

Larghezze, lunghezze, sezioni e forature non comprese in tabella vengono allestite su richiesta.

\* Le intensità ammissibili sono a titolo indicativo, esse dipendono dalle condizioni di installazione e di esercizio. Non possono implicare in nessun caso la responsabilità del costruttore.

Widths, lengths, sections and bores are not included in table above, they are provided at request.

\* All information concerning ampacity is not binding, the values shown above are approximate values. The manufacturer shall not be held responsible under any circumstance.

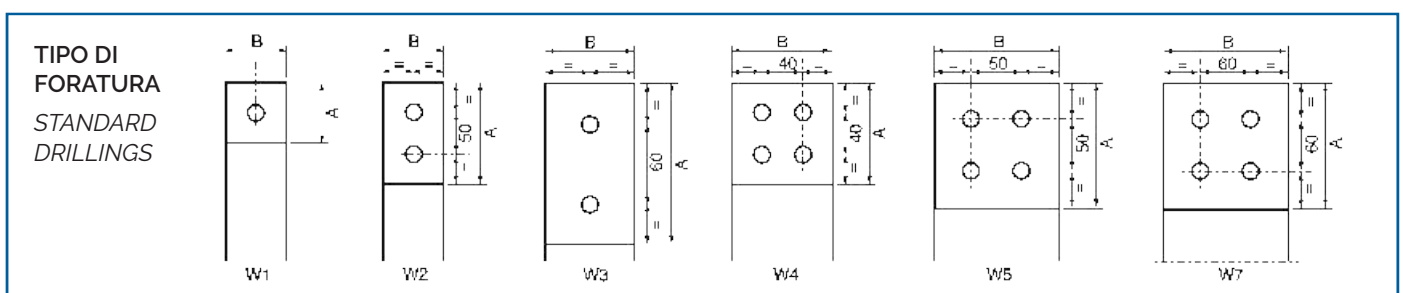

Ph AA



Ph AB



Ph AC



Ph AD



Ph AE



Ph AF

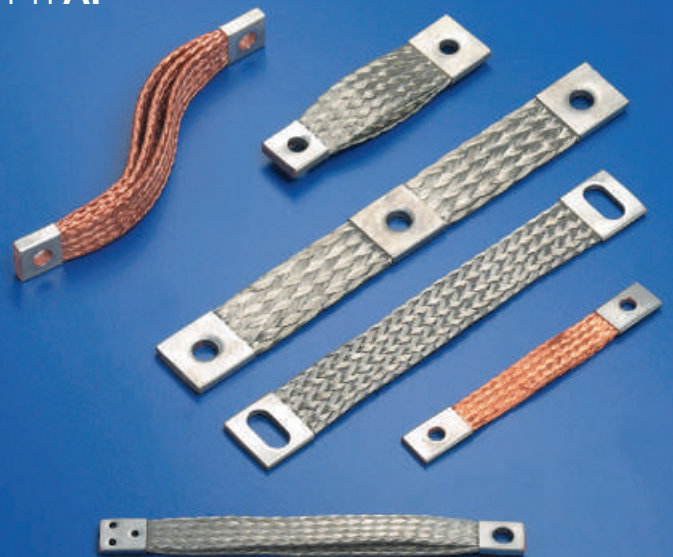

Ph AG

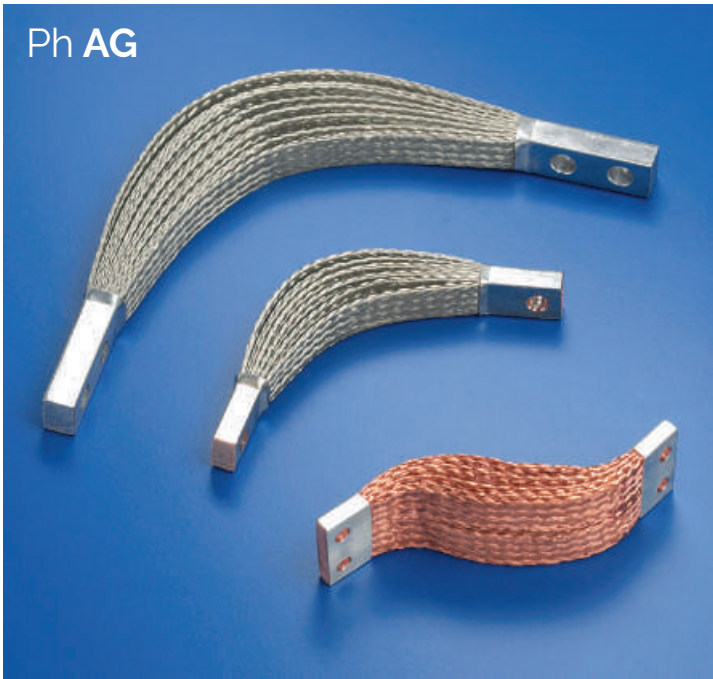

Ph AH



Ph AI

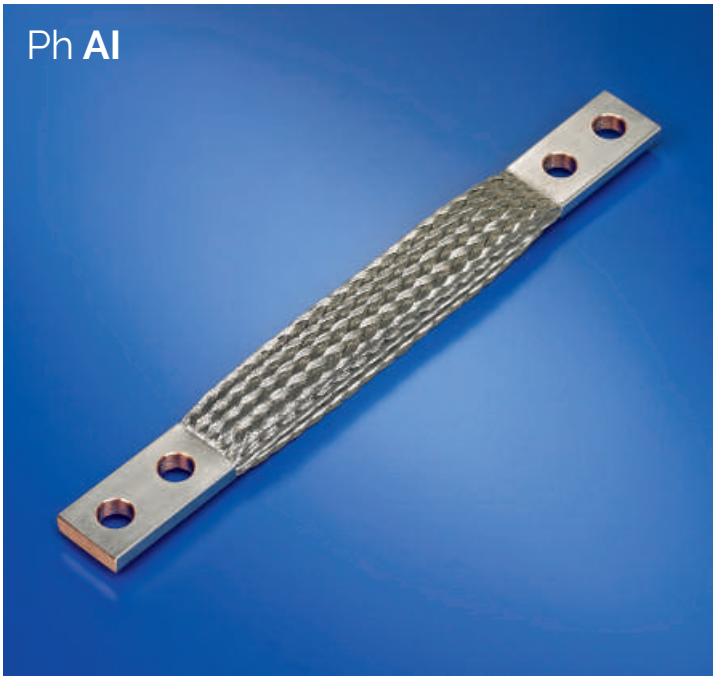

Ph AJ

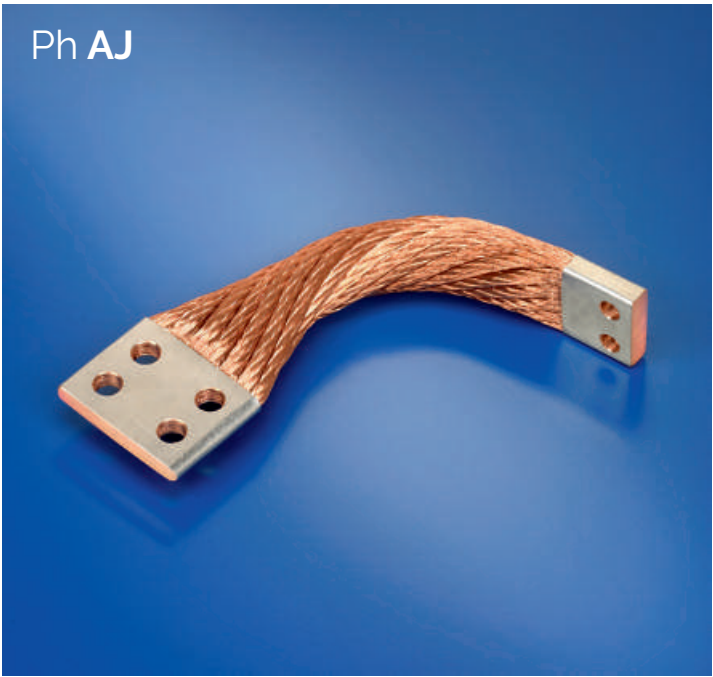

Ph AK



Ph AL



Ph AM



Ph AN



Ph AO



Ph AP



Ph AQ



Ph AR

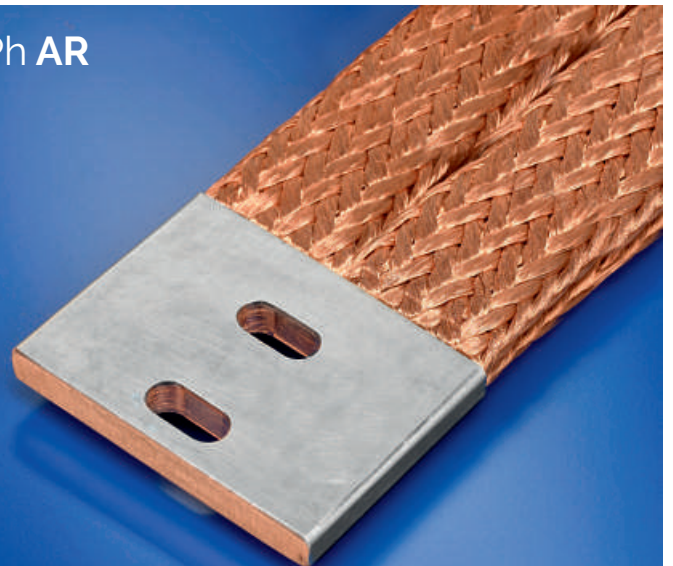

Ph AS

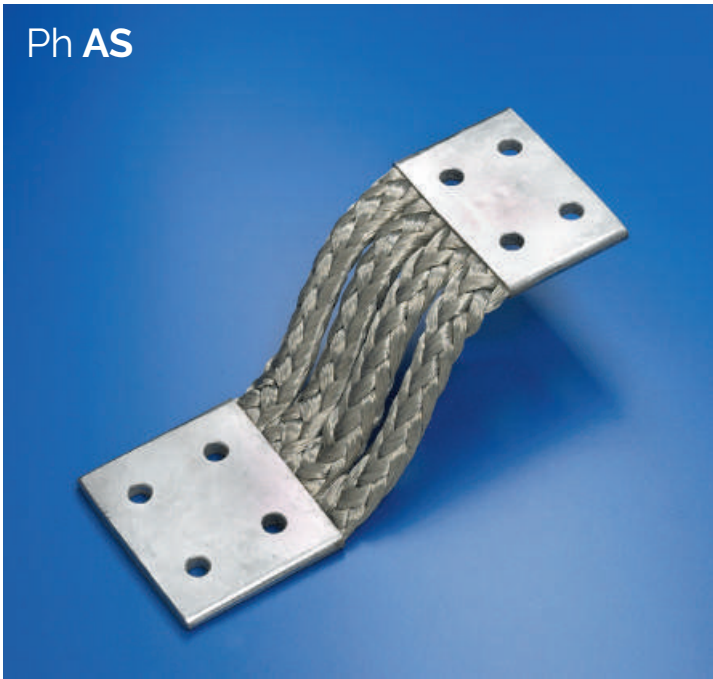

Ph AT



Ph AU

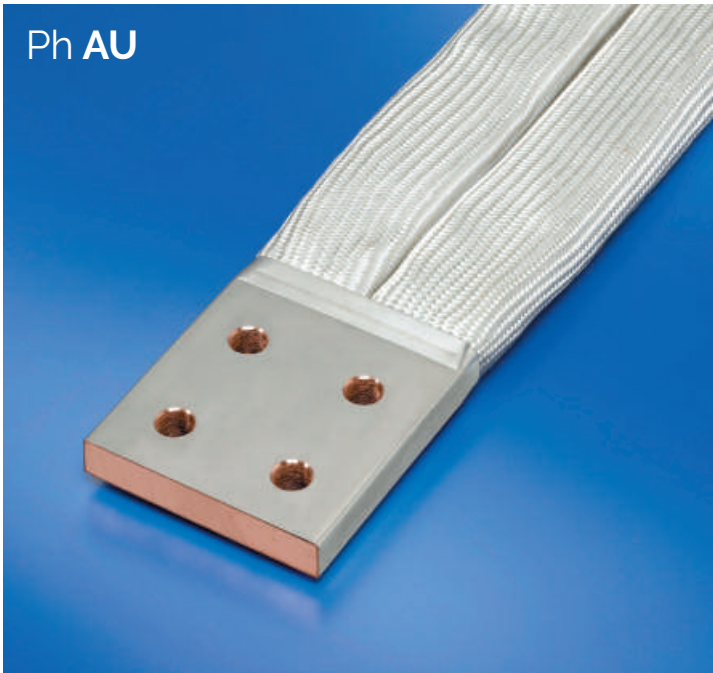

Ph AV



Ph AW



Ph AX



# COR-FLEX

## BARRE FLESSIBILI FLEXIBLE BARS

- ▶ Isolamento termoplastico di alta qualità  
*Thermoplastic insulating of high quality*
- ▶ Alta resistenza e omogeneità del profilo  
*High resistance and homogeneity of the shape*
- ▶ Profilo rettangolare con spigoli rinforzati  
*Rectangular shape with strengthened edges*
- ▶ Extraflessibile molto facile alla sguainatura  
*Extraflexible, very easy to be stripped*
- ▶ Adatto alla performance della barra  
*Suitable for the shaping of the bar*



	Unità di misura <i>Unit</i>	Metodo di analisi <i>Analysis</i>	Valore tipico <i>Value</i>
<b>CARATTERISTICHE COSTRUTTIVE   CHARACTERISTIC</b> Barre flessibili isolate in compound termoplastico esente da piombo ottenuto per estrusione monolitica. Normative di riferimento: CEI 20-14, CEI 20-35 <i>Insulated flexible bars in thermoplastic compound, lead free, obtained by monolithic extrusion. Specifications: CEI 20-14, CEI 20-35</i> <ul style="list-style-type: none"> <li>• Conduttore a lamelle di rame ricotto Cu-ETP   <i>Annealed copper strips Cu-ETP</i></li> <li>• Isolamento termoplastico   <i>Insulation</i></li> <li>• Temperatura di funzionamento   <i>Operating temperature</i></li> <li>• Tensione di esercizio   <i>Operating voltage</i></li> </ul>	UNI EN 1977-78:2000  °C V		Rame   <i>Copper</i> Thermoplastic -40 / 105 1000
<b>CARATTERISTICHE COSTRUTTIVE DEL CONDUTTORE CONDUCTOR CHARACTERISTIC</b> Rame rosso ricotto Cu-ETP in accordo alle norme UNI 5649 <i>Red copper Cu-ETP according to regulations:</i> UNI EN 1977-78:2000 / BS 1036 / DIN 1787 / ASTM 102 AFNOR A53-100			
<b>COMPOSIZIONE CHIMICA DEI MATERIALI CONDUTTORI CHEMICAL COMPOSITION OF CONDUCTOR MATERIALS</b> <ul style="list-style-type: none"> <li>• Cu</li> <li>• Bi</li> <li>• Pb</li> <li>• O<sub>2</sub></li> <li>• P</li> <li>• Carico di rottura   <i>Breaking load</i></li> <li>• Allungamento a rottura   <i>Elastic strenght</i></li> <li>• Resistività   <i>Resistivity</i></li> </ul>	% min % max % max % max % max Kg/mm <sup>2</sup> % Ohm x mm <sup>2</sup> / mm		99,9 0,001 0,005 0,04 - >=20 >=30 0,01754
<b>CARATTERISTICHE DELL'ISOLAMENTO INSULATIONS CHARACTERISTICS</b> Materiale isolante autoestinguento colore nero <i>Self extinguishing insulated material (colour black)</i> <ul style="list-style-type: none"> <li>• Massa volumica   <i>Volume mass</i></li> <li>• Indice di ossigeno   <i>Oxigen index</i></li> <li>• Durezza shore A   <i>Hardness shore A</i></li> <li>• Carico di rottura   <i>Breaking load</i></li> <li>• Allungamento a rottura   <i>Elastic strenght</i></li> <li>• Temperatura di irrigidimento a torsione   <i>Twist cold - shortness Temperature</i></li> <li>• Stabilità termica   <i>Thermic stability</i></li> <li>• Rigidità dielettrica   <i>Dielectric strenght</i></li> <li>• Resistività di volume a 20°C   <i>Volume resistivity at 20°C</i></li> </ul>	Kg/dm <sup>3</sup> % N/mm <sup>2</sup> % °C min. Kv/mm Ohm x cm	ISO 1183 ASTM D 2863 ISO 868 ISO 527 ISO 527 ISO 458/2 ISO 182 A ASTM D 149 ASTM D 257	UL94 V0 UL94 V0 1,4 23 76 15 >300 -41 210 >20 2 X 10 <sup>13</sup>
<b>CLASSIFICAZIONE NORMATIVA   SPECIFICATIONS ACCORDING TO:</b> CEI 20-21 e CEI 20-14 CEI 20-20 e CENELEC HD21 VDE 0207/86 BS6746/79			T12-R3

# Sezioni e intensità ammissibili

## Standard range, admissible currents

- ▶ Conduttore: rame rosso oppure stagnato  
Standard conductor: E-copper strips bare / tinned
- ▶ Lunghezza standard: 2m; su richiesta 3m oppure 4m  
Standard length: 2m
- ▶ Sezioni: da 25 a 1440 mm<sup>2</sup>  
Cross section: 25 to 1440 sq.mm
- ▶ Colore dell'isolante: nero  
Insulation colour: black

Dimensione delle barre di rame <sup>(1)</sup> Dimensions mm	Sezione Section [mm <sup>2</sup> ]	Portata [A] <sup>(2)</sup>   Ampacity		
		Δt 20°C <sup>(3)</sup>	Δt 40°C <sup>(4)</sup>	Δt 50°C <sup>(5)</sup>
9 x 0,8 x 4	28,8	120	180	210
9 x 0,8 x 6	43,2	160	230	270
15,5 x 0,8 x 2	24,8	125	175	200
15,5 x 0,8 x 3	37,2	160	210	240
15,5 x 0,8 x 4	49,6	195	265	295
15,5 x 0,8 x 6	74,4	225	320	360
15,5 x 0,8 x 10	124	300	420	480
20 x 1 x 2	40	170	240	270
20 x 1 x 3	60	230	320	360
20 x 1 x 4	80	270	380	440
20 x 1 x 5	100	300	430	490
20 x 1 x 6	120	330	470	530
20 x 1 x 10	200	420	580	650
24 x 1 x 2	48	200	280	320
24 x 1 x 3	72	250	360	410
24 x 1 x 4	96	280	410	460
24 x 1 x 5	120	330	470	530
24 x 1 x 6	144	360	510	570
24 x 1 x 8	192	420	590	670
24 x 1 x 10	240	500	700	790
32 x 1 x 2	64	230	320	360
32 x 1 x 3	96	280	410	460
32 x 1 x 4	128	320	460	520
32 x 1 x 5	160	390	550	610
32 x 1 x 6	192	440	620	700
32 x 1 x 8	256	510	720	800
32 x 1 x 10	320	600	840	930
40 x 1 x 3	120	330	480	540
40 x 1 x 4	160	400	560	630
40 x 1 x 5	200	450	630	710
40 x 1 x 6	240	480	680	750
40 x 1 x 8	320	600	830	920
40 x 1 x 10	400	670	920	1030

Dimensione delle barre di rame <sup>(1)</sup> Dimensions mm	Sezione Section [mm <sup>2</sup> ]	Portata [A] <sup>(2)</sup>   Ampacity		
		Δt 20°C <sup>(3)</sup>	Δt 40°C <sup>(4)</sup>	Δt 50°C <sup>(5)</sup>
50 x 1 x 3	150	400	570	650
50 x 1 x 4	200	490	700	790
50 x 1 x 5	250	540	780	880
50 x 1 x 6	300	590	840	950
50 x 1 x 8	400	680	1000	1130
50 x 1 x 10	500	750	1100	1300
63 x 1 x 4	252	550	780	880
63 x 1 x 5	315	650	900	1000
63 x 1 x 6	378	690	980	1100
63 x 1 x 8	504	840	1200	1350
63 x 1 x 10	630	920	1300	1450
63 x 1 x 12	756	1050	1450	1600
80 x 1 x 4	320	600	950	1090
80 x 1 x 5	400	700	1100	1230
80 x 1 x 6	480	780	1210	1360
80 x 1 x 8	640	950	1400	1570
80 x 1 x 10	800	1090	1550	1730
80 x 1 x 12	864	1200	1680	1880
100 x 1 x 4	400	700	1100	1250
100 x 1 x 5	500	860	1250	1400
100 x 1 x 6	600	950	1380	1530
100 x 1 x 8	800	1100	1580	1760
100 x 1 x 10	1000	1220	1710	1920
100 x 1 x 12	1200	1300	1800	2010
120 x 1 x 4	480	900	1300	1450
120 x 1 x 5	600	1000	1450	1600
120 x 1 x 6	720	1070	1530	1720
120 x 1 x 8	960	1250	1760	1950
120 x 1 x 10	1200	1360	1880	2110
120 x 1 x 12	1440	1500	2030	2200

- 1) Dimensioni: larghezza lamina x spessore di una lamina x n° delle lamine. Lo spessore dell'isolante varia in funzione della sezione da 1,5 a 2 mm.
- 2) Portata: Intensità di corrente ammissibile in Ampère con temperatura ambiente di 20°C, non ventilato.
- 3) Δt 20°C: Intensità di corrente corrispondente ad un rialzo termico di 20°C.
- 4) Δt 40°C: Valore medio di dimensionamento, corrispondente ad una sovratemperatura di 40°C.
- 5) Δt 50°C: Valore massimo consigliato, corrispondente ad un rialzo termico di 50°C. In caso di ventilazione forzata i valori si possono aumentare del 20-25%.

Le intensità di corrente ammissibili sono indicative, dipendono dalle condizioni di installazione e di esercizio e non possono in nessun caso implicare la responsabilità del costruttore. Il nostro laboratorio è a Vs. disposizione per effettuare, su richiesta, prove di sovratemperatura.

- 1) Dimensions: Copper-strips, number x dimensions, thickness 1,5-2 mm.
- 2) Ampacity: Acceptable currents with an ambiental temperature of 20°C.
- 3) Δt 20°C: Acceptable currents with 20°C temperature rise. 4) Δt 40°C: Acceptable currents with 40°C temperature rise.
- 5) Δt 50°C: Acceptable currents with 50°C temperature rise. By using a ventilated system it is possible to raise the current-load by approximately 20-25%.

The information regarding current flow are approximate values.

# BARRE FLESSIBILI SENZA ALOGENI con isolamento silicónico RHO

## SPECIAL FLEXIBLE BUSBARS HALOGEN FREE with silicone insulation RHO

- Isolante autoestinguente in accordo UL 94 VO  
*The insulation is self extinguishing in accordance with UL94VO*



### Caratteristiche isolante silicónico RHO:

**MESCOLA SILICONICA DYNASIL® Serie 1000**  
autoestinguente a bassa opacità e tossicità dei fumi secondo specifica FS 304142.

Colore dell'isolante	grigio
Temperatura massima	+250°C
Temperatura minima	-50°C
Tensione nominale	1000 V AC - 1500 V DC
Spessore della guaina	2 mm
Rigidità dielettrica	>21 Kv/mm
Reazione al fuoco	CSE classe 1
Determinazione classe di fumo	F1

### Silicone insulation characteristics:

**SILICON - DYNASIL® Serie 1000**  
*Low toxic fumes, opaque and self extinguishing in accordance with FS 304142 specification.*

<i>Insulation colour</i>	<i>grey</i>
<i>Maximum temperature</i>	<i>+250°C</i>
<i>Minimum temperature</i>	<i>-50°C</i>
<i>Operating voltage</i>	<i>1000 V AC - 1500 V DC</i>
<i>Sleeve thick</i>	<i>2 mm</i>
<i>Dielectric strength</i>	<i>&gt;21 Kv/mm</i>
<i>Reaction to fire (CSE)</i>	<i>class 1</i>
<i>Smoke class determination</i>	<i>F1</i>

# BARRE FLESSIBILI SENZA ALOGENI con isolamento speciale tipo HF

## FLEXIBLE BUSBARS HALOGEN FREE with special insulation HF

### Caratteristiche isolante tipo HF:

Temperatura di esercizio	-70°C +135°C
Colore dell'isolante	nero
Tensione nominale	1000V AC - 1500V DC
Rigidità dielettrica	22KV/mm
Shock termico	secondo UL 224
Piegatura a freddo	secondo UL 224
Resistenza a trazione	10,4 MPa Min
Allungamento a rottura	200% Min

### HF insulation characteristics:

<i>Operating temperature</i>	<i>-70°C +135°C</i>
<i>Insulation colour</i>	<i>black</i>
<i>Operating voltage</i>	<i>1000V AC - 1500V DC</i>
<i>Dielectric strength</i>	<i>22KV/mm</i>
<i>Heat shock</i>	<i>according to UL 224</i>
<i>Cold bend</i>	<i>according to UL 224</i>
<i>Tensile strength</i>	<i>10,4 MPa Min</i>
<i>Elongation at break</i>	<i>200% Min</i>

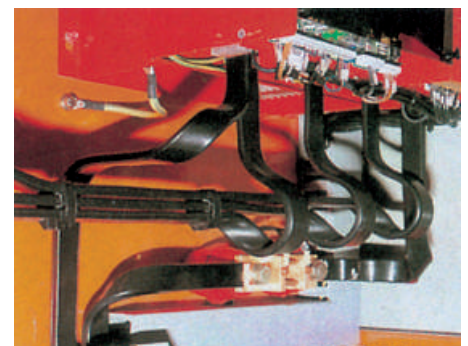
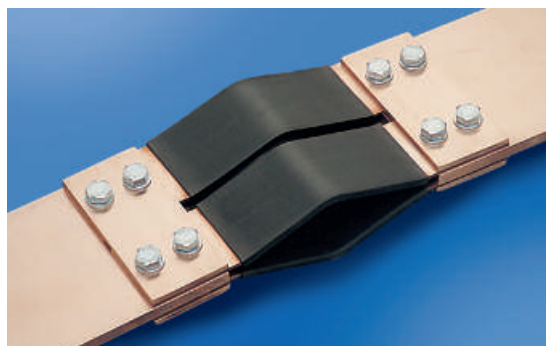



# ISOLATORI SPACERS INSULATORS

- ▶ Resina poliesteri colore rosso RAL 3002  
Glass reinforced polyester, red colour
- ▶ Inserti metallici femmina con filettatura metrica UNI 4534-64  
Female thread inserts, metric UNI 4534-64

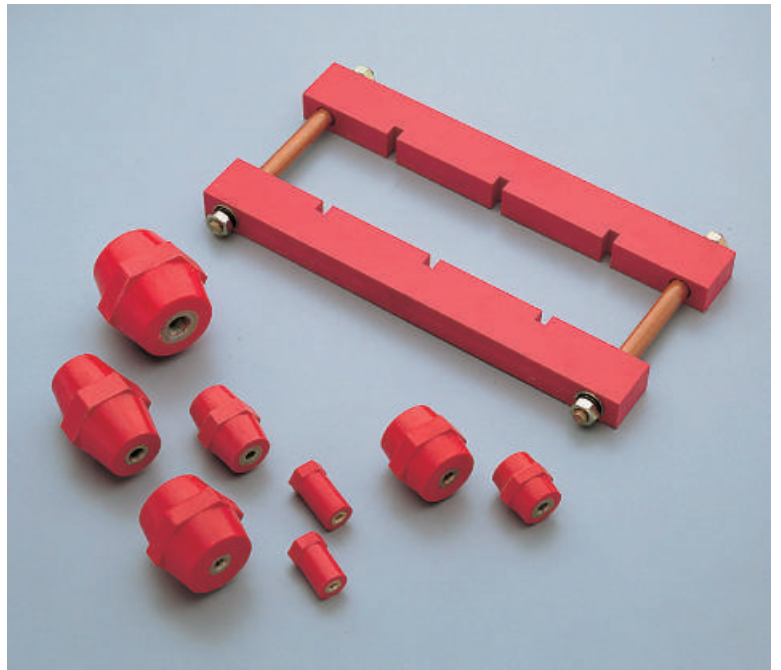
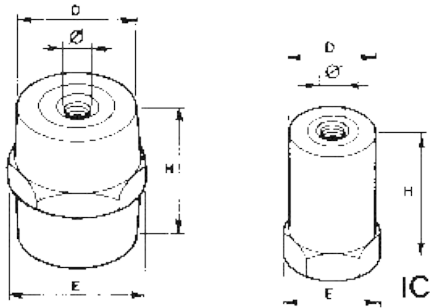

Cod.	Dimensioni   Dimensions				Carico rottura kg/kgm. Mechanical strong point kg/kgm				Tensione esercizio Operating voltage V-	Temper. esercizio Operating temper.	
	H mm.	D mm.	E mm.	Ø mm.	Trazione Strength	Compr. Compress	Torsione Twist	Taglio Bending			
IS 12 - 3	12	10	10	3 MA	—	—	—	—	110	- 40 + 130°C	
IS 16 - 4	16	12	15	4 MA	100	500	0,4	50	400		
IS 20 - 4	20	15	19	4 MA	150	600	0,4	60	600		
IS 25 - 5	25	18	22	5 MA	400	2400	3	180	600		
IS 30 - 6	30	26	30	6 MA	600	5000	3	300	600		
IS 30 - 8	30	26	30	8 MA	600	5000	3	300	600		
IS 35 - 6	35	29	32	6 MA	900	7000	5/10	500	1000		
IS 35 - 8	35	29	32	8 MA	900	7000	5/10	500	1000		
IS 35 - 10	35	29	32	10 MA	900	7000	5/10	500	1000		
IS 40 - 8 S	40	34	41	8 MA	1100	8500	10	850	1000		
IS 40 - 10 S	40	34	41	10 MA	1100	8500	10	850	1000		
IS 45 - 8 S	45	38	46	8 MA	1300	10000	10	850	1000		
IS 45 - 10 S	45	38	46	10 MA	1300	10000	10	850	1000		
IS 50 - 8	50	30	36	8 MA	900	7000	5/10	500	1000		
IS 50 - 10	50	30	36	10 MA	900	7000	5/10	500	2000		
IS 50 - 8 S	50	40	50	8 MA	1400	11000	10	850	2000		
IS 50 - 10 S	50	40	50	10 MA	1400	11000	10	850	2000		
IS 60 - 8 S	60	43	55	8 MA	1500	12000	10	850	3000		
IS 60 - 10 S	60	43	55	10 MA	1500	12000	10	850	3000		
IS 65 - 8	65	32	41	8 MA	1000	8500	5/10	600	3000		
IS 65 - 10	65	32	41	10 MA	1000	8500	5/10	600	3000		
IS 70 - 12 S	70	48	60	12 MA	3000	17000	10/15	1600	4000		
IS 75 - 10	75	38	50	10 MA	2400	12500	10/15	950	5000		
IS 75 - 12	75	38	50	12 MA	2400	12500	10/15	950	5000		
IS 100 - 12 S	100	52	65	12 MA	3000	17000	15	1600	8000		
IC 20/30 - 6	30	20	20	6 MA	400	2400	1,5	200	600		- 40 + 130°C
IC 20/35 - 6	35	20	20	6 MA	400	2400	1,5	200	600		
IC 20/35 - 8	35	20	20	8 MA	400	2400	1,5	200	600		
IC 20/40 - 6	40	20	20	6 MA	400	2400	1,5	200	600		
IC 20/40 - 8	40	20	20	8 MA	400	2400	1,5	200	600		
IC 30/40 - 8	40	30	30	8 MA	900	5000	2,5	300	1000		
IC 30/50 - 8	50	30	30	8 MA	900	5000	2,5	200	1000		
IC 30/60 - 8	60	30	30	8 MA	900	5000	2,5	150	1000		
IC 40/50 - 8	50	40	40	8 MA	1000	8000	3	500	1500		
IC 40/60 - 8	60	40	40	8 MA	1000	8000	3	370	1500		

# BANDELLE DI RAME

## BUSBARS - SOLID BARS

► Rame elettrolitico Cu-ETP  
Electrolytic Copper Cu-ETP Cu/A1

### Filettata m6 Threaded bars

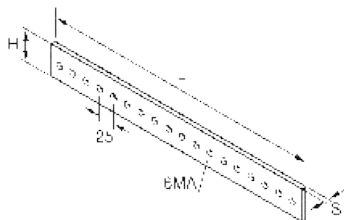

Cod.	Sezione mm <sup>2</sup> Section	H mm.	S mm.	L mm.	passo   pitch	Portata max Ampacity AC Amps
BF 15x2 M5/1	30	15	2	990	19	100
BF 15/1	75	15	5	990	25	230
BF 20/1	100	20	5	990	25	270
BF 30/1	150	30	5	990	25	370
BF 15/2	75	15	5	2000	25	230
BF 20/2	100	20	5	2000	25	270
BF 30/2	150	30	5	2000	25	370

### Perforata semplice Single perforated bars

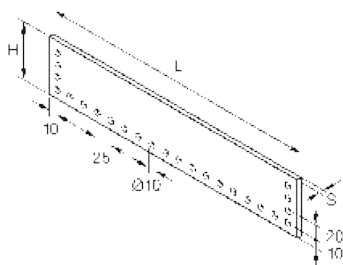

Cod.	Sezione mm <sup>2</sup> Section	H mm.	S mm.	L mm.	Portata max Ampacity AC Amps
BC 25/1.75	125	25	5	1750	325
BC 40/1.75	200	40	5	1750	480
BC 60/1.75	300	60	5	1750	680
BC 80/1.75	400	80	5	1750	880
BC 100/1.75	500	100	5	1750	1030

### Perforata doppia Double perforated bars

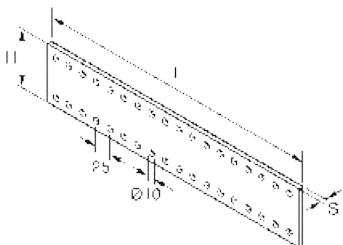

Cod.	Sezione mm <sup>2</sup> Section	H mm.	S mm.	L mm.	Portata max Ampacity AC Amps
BD 50/1.75	250	50	5	1750	580
BD 60/1.75	300	60	5	1750	680
BD 80/1.75	400	80	5	1750	880
BD 100/1.75	500	100	5	1750	1030
BD 125/1.75	625	125	5	1750	1100

### Bandella piena lunghezza 2m circa Plain bars about 2m long

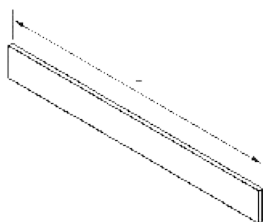

Cod.	Sezione mm <sup>2</sup> Section	Cod.	Sezione mm <sup>2</sup> Section
BA 30 x 3	90	BA 50 x 8	400
BA 20 x 5	100	BA 60 x 8	480
BA 30 x 5	150	BA 80 x 8	640
BA 40 x 5	200	BA 100 x 8	800
BA 50 x 5	250	BA 20 x 10	200
BA 60 x 5	300	BA 30 x 10	300
BA 80 x 5	400	BA 40 x 10	400
BA 100 x 5	500	BA 50 x 10	500
BA 50 x 6	300	BA 60 x 10	600
BA 60 x 6	360	BA 80 x 10	800
BA 80 x 6	480	BA 100 x 10	1000

Larghezze, lunghezze, sezioni e forature non comprese in tabella vengono allestite su richiesta.

\* Le intensità ammissibili sono a titolo indicativo, esse dipendono dalle condizioni di installazione e di esercizio. Non possono implicare in nessun caso la responsabilità del costruttore.





Widths, lengths, sections and bores are not included in table above, they are provided at request.

\* All information concerning ampacity is not binding, the values shown above are approximate values. The manufacturer shall not be held responsible under any circumstance.

## Portate di corrente ammissibili nelle sbarre di rame

### Cu ETP crudo UNI EN 1977-78: 2000

#### Acceptable current values for Cu ETP UNI EN 1977-78: 2000, raw copper

Dimensioni h x s mm <i>Dimensions</i>	Sezione mm <sup>2</sup> <i>Section</i>	Portata sbarre a 50/60 Hz Amp. <i>Bar's ampacity at 50/60 Hz. in Amps</i>				Peso Kg/m <i>Weight</i>
		1 	2 	3 	4  $>50$ 	
15 x 3	45	160	280			0,400
20 x 3	60	200	340			0,534
25 x 3	75	240	405			0,667
30 x 3	90	280	465			0,801
40 x 3	120	360	590			1,068
20 x 4	80	240	410			0,712
25 x 4	100	280	470			0,890
30 x 4	120	300	495			1,068
40 x 4	160	380	620			1,424
50 x 4	200	450	735			1,780
20 x 5	100	270	500	680		0,890
25 x 5	125	325	580	790		1,112
30 x 5	150	370	655	875		1,335
40 x 5	200	465	810	1050		1,780
50 x 5	250	575	980	1240	1900	2,225
60 x 5	300	660	1130	1380	2150	2,670
80 x 5	400	850	1420	1675	2620	3,560
100 x 5	500	1055	1725	2000	3150	4,450
40 x 6	240	505	880		1140	2,136
50 x 6	300	600	1035	1290	1980	2,670
60 x 6	360	710	1215	1485	2310	3,204
80 x 6	480	930	1560	1840	2850	4,272
100 x 6	600	1120	1825	2120	3330	5,340
40 x 8	320	575		1005	1275	2,848
50 x 8	400	700	1200	1510	2320	3,560
60 x 8	480	820	1400	1715	2665	4,272
80 x 8	640	1060	1770	2090	3255	5,696
100 x 8	800	1265	2060	2390	3750	7,120
50 x 10	500	850	1500	2030	2600	4,450
60 x 10	600	970	1700	2270	2850	5,340
80 x 10	800	1230	2100	2750	2400	7,120
100 x 10	1000	1480	2460	3240	3960	8,900
120 x 10	1200	1700	2800	3700	4450	10,680

Note: Tabella delle portate secondo DIN 43671, E-Cu F30, sbarre lucide a spigolo vivo, valori approssimati e non impegnativi.

Temperatura ambiente 35°C, sovratemperatura di 30°C. Sbarre posizionate verticalmente, intervallo fra le sbarre in parallelo uguale allo spessore di una sbarra.

Note: Table is in accordance with DIN 43671, E-Cu F30, the bars which are described are bright with sharp edges, the values shown above have been approximated but shall not be respected rigidly.

Ambient temperature is equal to 35°C (95°F), overheat temperature is equal to 30°C (86°F). Bars are positioned vertically, the distance between the bars in parallel, is equal to the thickness of one bar.

## Caratteristiche Meccaniche Pl Cu-ETP secondo UNI 3310-72

### Mechanical Characteristics, Pl Cu-ETP according to UNI 3310-72

Stato fisico <i>Physical state</i>	R Kg/mm <sup>2</sup>	A %	HB Kg/mm <sup>2</sup>	Corrispondenza DIN <i>Corresponding DIN</i>	Corrispondenza AFNOR <i>Corresponding AFNOR</i>	
Ricotto / <i>Annealed</i>	R	20-26	40	40-60	E - Cu F20	Cu A1 O
Incrudito / <i>Work-Hardened</i>	H 10	26-32	15	60-85	E - Cu F25	Cu A1 H11
Incrudito / <i>Work-Hardened</i>	H 20	30-37	5	75-100	E - Cu F30	Cu A1 H12
Incrudito / <i>Work-Hardened</i>	H 30	≥ 37	2	≥ 90	E - Cu F37	Cu A1 H14

UNI EN 1977-78: 2000 corrispondente alle norme: ASTM n. 102

UNI EN 1977-78: 2000 corresponds to the following specifications: AFNOR A53-100 | DIN 1787 | BS 1036 | VSM 10826.



 **COREX** SRL

Via S. Giacomo, 8 | 10092 BEINASCIO TO ITALY | Tel. +39.011.349.7796 | Fax +39.011.397.1436  
www.corex.it | e-mail: corex@corex.it

